



# X3-FORTH

**40 kW-LV / 50 kW-LV / 60 kW-LV / 70 kW-LV  
75 kW / 80 kW / 99.9 kW / 100 kW / 110 kW /  
120 kW / 125 kW / 136 kW-MV / 150 kW-MV**

## User Manual

Version 17.0

[www.solaxpower.com](http://www.solaxpower.com)



eManual in the QR code or  
at [www.solaxpower.com](http://www.solaxpower.com)



# STATEMENT

---

## Copyright

Copyright © SolaX Power Network Technology (Zhejiang) Co., Ltd. All rights reserved.

No part of this manual may be reproduced, transmitted, transcribed, stored in a retrieval system, or translated into any language or computer language, in any form or by any means without the prior written permission of SolaX Power Network Technology (Zhejiang) Co., Ltd.

## Trademarks



**SOLA<sup>X</sup>** and other symbol or design (brand name, logo) that distinguishes the products or services offered by SolaX has been trademark protected. Any unauthorized use of the above stated trademark may infringe the trademark right.

## Notice

Please note that certain products, features, and services mentioned in this document may not be within the scope of your purchase or usage. Unless otherwise specified in the contract, the contents, information, and recommendations presented in this document are provided "as is" by SolaX. We do not provide any warranties, guarantees, or representations, whether express or implied.

The content of the documents is reviewed and updated as needed. However, occasional discrepancies may occur. SolaX retains the right to make improvements or changes in the product(s) and the program(s) described in this manual at any time without prior notice.

The images included in this document are solely for illustrative purposes and may differ based on the specific product models.

For more detailed information, kindly visit the website of SolaX Power Network Technology (Zhejiang) Co., Ltd. at [www.solaxpower.com](http://www.solaxpower.com).

SolaX retains all rights for the final explanation.



Item	Meaning	Description
4	(L)	Models with (L) have LCD screen. Models without (L) have LED indicators.



## Target Group

The installation, maintenance and grid-related setting can only be performed by qualified personnel who:

- Are licensed and/or satisfy state and local regulations.
- Have good knowledge of this manual and other related documents.

## Conventions

The symbols that may be found in this manual are defined as follows.

Symbol	Description
 <b>DANGER</b>	Indicates a hazardous situation which, if not avoided, will result in death or serious injury.
 <b>WARNING</b>	Indicates a hazardous situation which, if not avoided, could result in death or serious injury.
 <b>CAUTION!</b>	Indicates a hazardous situation which, if not avoided, could result in minor or moderate injury.
<b>NOTICE!</b>	Provides tips for the optimal operation of the product.

## Change History

### Version 17.0 (2025-10-13)

Updated "9. [Operation on LCD](#)", deleted PV Connection function.

### Version 16.0 (2025-08-14)

Add 99.9 kW model and its related contents.

Add related contents of AFCI.

Updated "9. [Operation on LCD](#)", added Shut Down function.

Updated the recommended specifications of 80kW-110kW AC breakers.

Updated the QR code of the cover.

### Version 15.0 (2025-07-09)

Add BIS mark of conformity.

Updated the device's dimensions.

#### **Version 14.0 (2025-05-07)**

Updated "1. Safety" (Added note of equipment appearance differences).

Updated figures of lifting the inverter.

Updated ground screw and torsion during AC wiring.

Updated figures of SolaxCloud Web page.

Updated "13 Technical Data".

Updated notes of differences of packing list in different countries/regions.

#### **Version 13.0 (2024-11-22)**

Updated "7.4 PV Connection" (Added PV terminal connection recommendations and PV terminal configuration Information).

Updated "9. Operation on LCD" (Added updated interfaces).

Updated "11.4 Upgrading Firmware" (Added Updated the upgrade steps).

Updated "13 Technical Data".

Updated the bottom view figure of the inverter and the format of the manual according to the latest template.

#### **Version 12.0 (2024-08-14)**

Modified APP Setting and Start the Inverter.

Modified Installation Environment Required.

Added remark about Packing List.

Added fireproof mud sealing note for Grid Connection.

Updated the format of the manual according to the latest template.

#### **Version 11.0 (2024-03-07)**

Added contents about PV dust proof buckles.

Modified Grounding Connection.

#### **Version 10.0 (2024-03-05)**

Modified PV terminals.

#### **Version 9.0 (2024-01-22)**

Deleted PV Connection information and UKCA.

Updated LCD description and used MC4 terminals.

Updated information of packing list.

Deleted PLC information.

#### **Version 8.0 (2023-07-18)**

Added local MODBUS parallel function description.

Modified Troubleshooting.

Added OT terminal instructions.

#### **Version 7.0 (2023-04-19)**

Added the data of 75 kW, 100 kW 12 MPPT and 110kW 12 MPPT.

**Version 6.0 (2023-02-15)**

Added Change History.

Updated 2.3 Explanation of Symbols (Modified the explanations of symbols).

Updated diagram of PLC connection.

Updated 4 Technical Data (Modified and added new items).

**Version 5.0 (2022-09-12)**

Modified the neutral version.

Added a diagram to PLC Box connection.

Updated USB.

**Version 4.0 (2022-03-15)**

Added information of the screen version.

**Version 3.0 (2021-11-26)**

Modified the layout of contents, technical data and schematic diagram.

**Version 2.0 (2021-11-26)**

Added low voltage and all related contents.

**Version 1.0 (2021-10-23)**

Added The communication line is changed to 30 cores.

**Version 0.0 (2021-09-25)**

Initial release

# Table of Contents

---

- 1 Safety ..... 1
  - 1.1 General Safety ..... 1
  - 1.2 Safety Instructions of PV, Inverter and Grid ..... 1
    - 1.2.1 Safety Instructions of PV ..... 1
    - 1.2.2 Safety Instructions of Inverter ..... 3
    - 1.2.3 Safety Instructions of Utility Grid ..... 5
- 2 Product Overview ..... 6
  - 2.1 Product Introduction ..... 6
  - 2.2 Appearance ..... 8
  - 2.3 Symbols on the Label and Inverter ..... 9
  - 2.4 Working Principle ..... 11
  - 2.5 Working State ..... 13
- 3 Transportation and Storage ..... 14
- 4 Preparation before Installation ..... 16
  - 4.1 Selection of Installation Location ..... 16
    - 4.1.1 Environment Requirement ..... 16
    - 4.1.2 Installation Carrier Requirement ..... 17
    - 4.1.3 Clearance Requirement ..... 18
  - 4.2 Tools Requirement ..... 19
  - 4.3 Additionally Required Materials ..... 20
- 5 Unpacking and Inspection ..... 21
  - 5.1 Unpacking ..... 21
  - 5.2 Scope of Delivery ..... 22
- 6 Mechanical Installation ..... 24
  - 6.1 Dimensions for mounting ..... 25
  - 6.2 Installation procedures ..... 25
- 7 Electrical Connection ..... 33
  - 7.1 Overview of Electrical Connection ..... 33
    - 7.1.1 Terminals of Inverter ..... 33
    - 7.1.2 Cable Connections of Inverter ..... 35
  - 7.2 PE Connection ..... 37
  - 7.3 AC Side Connection ..... 39
  - 7.4 PV Connection ..... 44

7.4.1	PV Terminal Connection Recommendations for 9 MPPT Models.....	45
7.4.2	PV Terminal Connection Recommendations for 12 MPPT Models.....	51
7.4.3	PV Wiring Procedure .....	58
7.5	Communication Connection.....	62
7.6	Monitoring Connection .....	66
<b>8</b>	<b>System Commissioning .....</b>	<b>68</b>
8.1	Checking before Power-on .....	68
8.2	Powering on the System.....	68
<b>9</b>	<b>Operation on LCD.....</b>	<b>70</b>
9.1	Introduction of Control Panel.....	70
9.2	Main interface .....	72
9.3	Status .....	73
9.3.1	Grid Setting .....	73
9.3.2	Solar Setting .....	73
9.4	Meter.....	74
9.5	History .....	74
9.6	Settings .....	74
9.6.1	Using Users' Password .....	75
9.6.2	Using Installer password .....	77
9.7	About.....	91
<b>10</b>	<b>Operation on SolaX App and Web.....</b>	<b>92</b>
10.1	Introduction of SolaXCloud.....	92
10.2	Operation Guide on SolaXCloud App .....	92
10.2.1	Downloading and Installing App .....	92
10.2.2	Operation on the App.....	93
10.3	Operations on SolaXCloud Web page.....	93
<b>11</b>	<b>Troubleshooting and Maintenance .....</b>	<b>94</b>
11.1	Power off.....	94
11.2	Troubleshooting.....	94
11.3	Maintenance.....	104
11.4	Upgrading Firmware .....	106
<b>12</b>	<b>Decommissioning.....</b>	<b>108</b>
12.1	Disassembling the Inverter .....	108
12.2	Packing the Inverter .....	110
12.3	Disposing of the Inverter .....	110
<b>13</b>	<b>Technical Data .....</b>	<b>111</b>
13.1	DC Input .....	111

13.2 AC Output.....112

13.3 System data .....113

13.4 Protection .....114

13.5 Standard .....116

**14 Appendix ..... 117**

14.1 Control Output Power with RRCR.....117

14.2 Application of Parallel Function .....119

# 1 Safety

---

## 1.1 General Safety

The series inverter has been meticulously designed and thoroughly tested to comply with the relevant state and international safety standards. Nevertheless, like all electrical and electronic equipment, safety precautions must be observed and followed during the installation of the inverter to minimize the risk of personal injury and ensure a safe installation.

Please thoroughly read, comprehend, and strictly adhere to the comprehensive instructions provided in the user manual and any other relevant regulations prior to the installation of the inverter. The safety instructions in this document serve as supplementary guidelines to local laws and regulations.

SolaX shall not be liable for any consequences resulting from the violation of the storage, transportation, installation, and operation regulations outlined in this document. Such consequences include, but are not limited to:

- Inverter damage caused by force majeure events, such as earthquakes, floods, thunderstorms, lightning, fire hazards, volcanic eruptions, and similar events.
- Inverter damage due to human causes.
- Usage or operation of the inverter in violation of local policies or regulations.
- Failure to comply with the operation instructions and safety precautions provided with the product and in this document.
- Improper installation or usage of the inverter in unsuitable environmental or electrical conditions.
- Unauthorized modifications to the product or software.
- Inverter damage occurring during transportation by the customer.
- Storage conditions that do not meet the requirements specified in this document.
- Installation and commissioning performed by unauthorized personnel who lack the necessary licenses or do not comply with state and local regulations.

## 1.2 Safety Instructions of PV, Inverter and Grid

Save these important safety instructions. Failure to follow these safety instructions may result in damage to the inverter and injury or even loss of life.

### 1.2.1 Safety Instructions of PV

 **DANGER!**

**Potential risk of lethal electric shock associated with the photovoltaic (PV) system**

- Exposure to sunlight can result in the generation of high DC voltage by PV modules, which can lead to electric shock causing severe injuries or even death.
- Never touch the positive or negative poles of the PV connecting device, and avoid touching both poles simultaneously.
- Do not ground the positive or negative poles of the PV modules.
- Never operate on PV connectors, the MAINS cables, PV cables or the PV generator when power is applied.
- After switching off the PV and Mains, always wait 5 minutes to let the intermediate circuit capacitors discharge before unplugging DC and MAINS connectors.
- Only qualified personnel can perform the wiring of the PV modules.

 **WARNING!**

**Over voltage protection with surge arresters should be provided when the PV system is installed. The inverter is fitted with SPDs on both PV input side and MAINS side.**

- Induced surges are the more likely cause of lightning damage in the majority of installations, especially in rural areas where electricity is usually provided by long overhead lines. Surges may be induced on both the PV array conductors or the AC cables leading to the building. Specialists in lightning protection should be consulted in the actual application.
- Using appropriate external lightning protection, the effect of a direct lightning strike into a building can be mitigated in a controlled way, and the lightning current can be discharged into the ground. Installation of SPDs to protect the inverter against mechanical damage and excessive stress includes a surge arrester in the case of a building with external lightning protection system (LPS) when separation distance is kept.
- To protect the DC system, surge protection device (SPD type 2) should be fitted at the inverter end of the DC cabling and at the array located between the inverter and the PV generator, if the voltage protection level (VP) of the surge arresters is greater than 1100V, an additional SPD type 2 is required for surge protection for electrical devices.
- To protect the AC system, surge protection devices (SPD type 2) should be fitted at the main incoming point of AC supply (at the consumer's cutout) , located between the inverter and the meter / distribution system; SPD (test impulse D1) for signal line according to EN 61632-1.
- Spark gap protection devices are not suitable to be used in DC circuits once conducting, they won't stop conducting until the voltage passes through their terminals typically less than 30 volts.

 **WARNING!**

- Make sure that the input DC voltage does not exceed the maximum DC input voltage specified for the inverter. Over voltage can cause irreversible damage to the inverter, and such damage is not covered by the warranty.

**WARNING!**

- Photovoltaic modules should meet the IEC 61730 Class A standards.

**NOTICE!****Grounding the PV generator.**

- Comply with the local requirements for grounding the PV modules and the PV generator in order to have optimal protection of system and persons.

**1.2.2 Safety Instructions of Inverter****DANGER!****Potential risk of lethal electric shock associated with the inverter**

- Only operate the inverter if it is in a technically faultless condition. Operating a faulty inverter may lead to electric shock or fire.
- Do not attempt to open the enclosure without authorization from SolaX. Unauthorized opening of the enclosure will void the warranty and can result in lethal danger or serious injury due to electric shock.
- Make sure that the inverter is reliably grounded before any operation to prevent the risk of electric shock causing lethal danger or serious injury.
- Only qualified personnel can perform the installation, wiring, maintenance of the inverter by following this document and the related regulations.

**WARNING!****High leakage current!**

- The inverter incorporates a certified internal Residual Current Device (RCD) in order to protect against possible electrocution and fire hazards in case of a malfunction in the cables or the inverter. There are two-trip thresholds for the RCD as required for certification (IEC 62109-2: 2011) .
- The default value for electrocution protection is 30 mA, and for slow rising current is 300 mA.
- If an external RCD is required by local regulations, check which type of RCD is required for relevant electric code. It recommends using a type-A RCD. The recommended RCD value is 300 mA unless a lower value is required by the specific local electric codes. When required by local regulations, the use of an RCD type B is permitted.
- The device is intended to connect to a PV generator with a capacitance limit of approx 700 nf.
- Use insulated tools when installing the device, and always wear personal protective equipment during installation and maintenance.

 **WARNING!**

**Earth connection essential before connecting supply.**

- Incorrect grounding can cause physical injury, death, or equipment malfunction and increase electromagnetic.
- Make sure that grounding conductor is adequately sized as required by safety regulations.
- Do not connect the ground terminals of the unit in series in case of a multiple installation. This product can cause current with a DC component.
- For the United Kingdom: The installation that connects the equipment to the supply terminals shall comply with the requirements of BS 7671. The Electrical installation of PV system shall comply with requirements of BS 7671 and IEC 60364-7-712.
- No protection settings can be altered without authorization. The installer shall ensure that equipment is installed and operated to maintain at all times in compliance with the requirements of ESQCR22 (1) (a) .
- For Australia and New Zealand: Electrical installation and maintenance shall be conducted by licensed electrician and shall comply with Australia National Wiring Rules.

 **WARNING!**

**Hazardous voltage present for up to 5 minutes after disconnection from power supply.**

- Never connect or disconnect the AC and DC connector while the inverter is running.
- Prior to conducting any maintenance, turn off the AC and DC power and disconnect them from the inverter. Wait for 5 minutes to fully discharge the energy.

 **WARNING!**

**Potential danger of scalding due to the hot enclosure of the inverter**

- During operation, avoid touching any parts of the inverter, except for the DC switch and LCD panel (if any), as it becomes hot and may cause personal injuries.

 **CAUTION!**

- Make sure that children are supervised to prevent them from playing with the inverter.
- Pay attention to the weight of the inverter and handle it properly to avoid personal injuries.
- Possible damage to health as a result of the effects of radiation. Do not stay closer than 20 cm to inverter for any length of time.

**NOTICE!**

- All the product labels and nameplate on the inverter shall be maintained clearly visible.
- The diagrams in this document are for reference only; the actual appearance of the received device shall prevail.

### 1.2.3 Safety Instructions of Utility Grid

#### NOTICE!

##### Anti-Islanding Effect

- The inverter provides Active Frequency Drift (AFD) to prevent islanding effect. Islanding effect is a special phenomenon that grid-connected PV system still supplies power to the nearby grid when electrical grid power is no longer present. It is dangerous for maintenance personnel and the public.

#### NOTICE!

- Only connect the inverter to the grid with the permission of the local utility grid company.

## 2 Product Overview

### 2.1 Product Introduction

#### Photovoltaic Grid Connected System

X3-FORTH is a three-phase transformerless grid-connected inverter, which is an important component of photovoltaic (PV) power generation systems. The inverter converts the direct current (DC) generated by the PV panels into alternating current (AC) that meets grid requirements and feeds it into the grid.

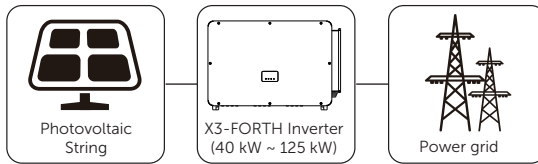

Figure 2-1 Typical application scenario for 40 kW ~ 125 kW inverters

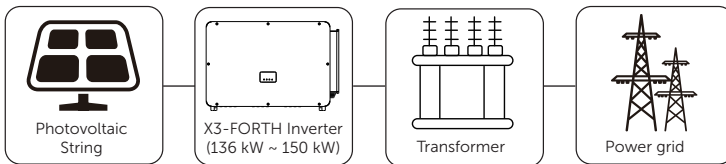

Figure 2-2 Typical application scenario for 136 kW ~ 150 kW inverters

#### ⚠ WARNING!

- The inverter shall not be connected to the PV string requiring positive grounding or negative grounding.
- Do not connect local load between inverter and AC side circuit breaker!

#### Supported Power Grid

There are different ways of wiring for different grid systems. The power grids supported by the inverter are TN-S, TN-C, TN-C-S, TT and IT.

40 kW-70 kW inverters are connected to 127 V / 220 V three-phase four wire power grid and 75 kW-125 kW inverters are connected to 220 V / 380 V three-phase four wire power grid, which can be connected with N line (or not), as shown in Figure 2-3.

136 kW and 150 kW models are directly connected to the medium voltage power grid through a 500 V or 540 V transformer without an N line access, as shown in Figure 2-4.

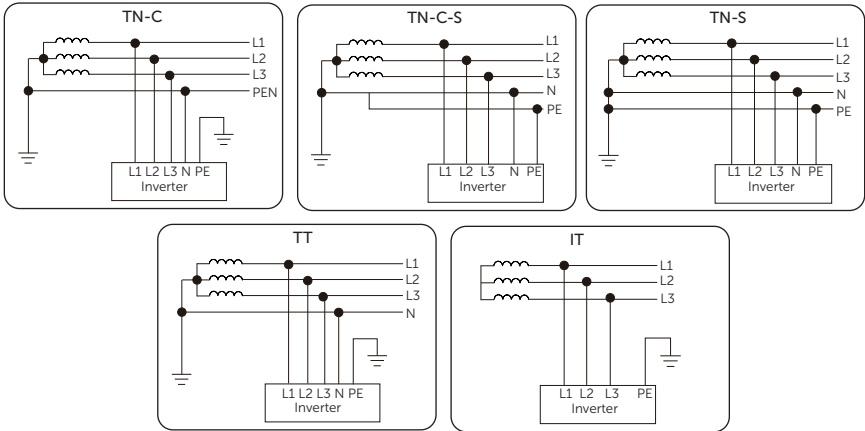

Figure 2-3 40 kW-125 kW inverters supported power grid

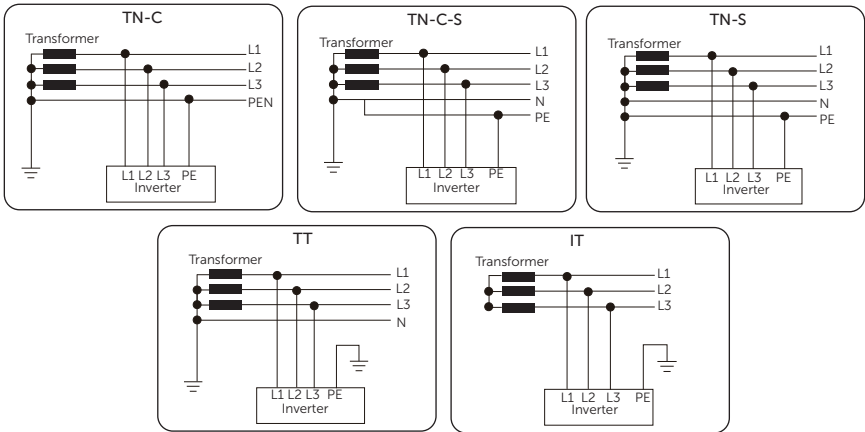

Figure 2-4 136 kW and 150 kW inverters supported power grid

### Basic Features

The X3-FORTH Series Inverter offers high efficiency with a peak performance of up to 99%. It supports a wide MPPT voltage range from 180 to 1000Vdc and includes up to 12 MPPTs, each with 2 strings per tracker. This allows for flexible solar panel setups and helps to maximize energy production. The inverter can handle 150% PV over-sizing input and 110% overloading output, with a maximum MPPT current of 32A.

For safety, X3-FORTH Series Inverter is built to last with an IP66 rating, protecting it from dust and water. It includes AFCI protection (optional), temperature detection at the AC terminal, and surge protection devices (SPDs) for both AC and DC circuits. An optional Type I+II SPD is also available.

Additional features include export power control, remote maintenance, and 24-hour operation monitoring. The inverter also supports smart solar panel I-V Curve Diagnosis and night-time reactive power compensation. Its compact and lightweight design, with advanced heat dissipation, makes it more efficient and easier to install. The X3 Forth Series Inverter is a reliable choice for effective and safe solar power generation.

## 2.2 Appearance

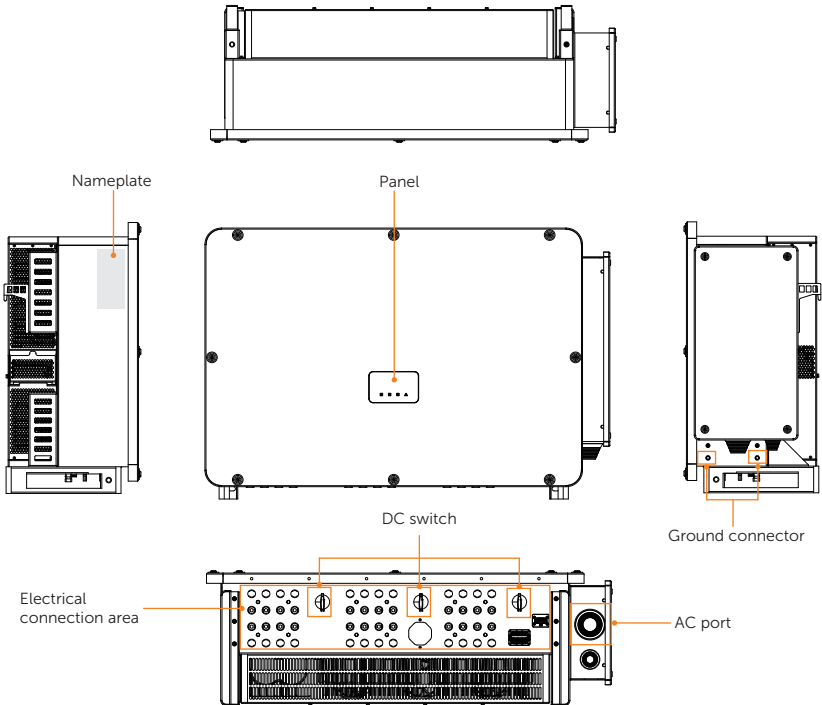









Figure 2-5 Appearance

Table 2-1 Description of appearance

Item	Description
Nameplate	Nameplate clearly identifies the device type, serial number, specific DC / AC parameters, certification, etc.
Panel	Models with (L) have an LCD screen and keys. The screen displays information, and the keys are used for parameter setting. Models without (L) only have LED indicators which show the status of the inverter.
DC switch	Disconnect PV input when necessary.
Ground connector	The PE wire (ground wire) of the inverter must be reliably grounded.
AC port	The AC cable connects to the AC terminals in the wiring box by passing through this AC port.
Electrical connection area	Including grid terminals, PV terminals and communication terminals.









## 2.3 Symbols on the Label and Inverter

Table 2-2 Description of symbols

Symbol	Description
	CE mark. The inverter complies with the requirements of the applicable CE guidelines.
	TUV certified.
	RCM mark. The inverter complies with the requirements of the applicable RCM guidelines.
	Additional grounding point.
	Beware of hot surface. Do not touch a running inverter, as the inverter becomes hot during operation!
	Risk of electric shock. High voltage exists after the inverter is powered on!
	Risk of danger. Potential hazards exist after the inverter is powered on!

## Product Overview

---

Symbol	Description
	BIS mark of conformity
	NOM-001
	UL1741
	Read the enclosed documentations.
	Do not dispose of the inverter together with household waste.
	Do not operate this inverter until it is isolated from mains and on-site PV generation source.
 	Danger of high voltage. Do not touch live parts for 5 minutes after disconnection from the power sources.

Note: The table is only used for the description of symbols which may be used on the inverter. Please be subject to the actual symbols on the device.

## 2.4 Working Principle

The inverter is equipped with multi-channel MPPT for DC input to ensure maximum power even under different photovoltaic input conditions. The inverter unit converts direct current into alternating current that meets the requirements of the power grid and feeds it into the power grid. The lightning arrester at AC/ DC sides can realize the function of surge protection. The principle design of inverter is shown in the figure below:

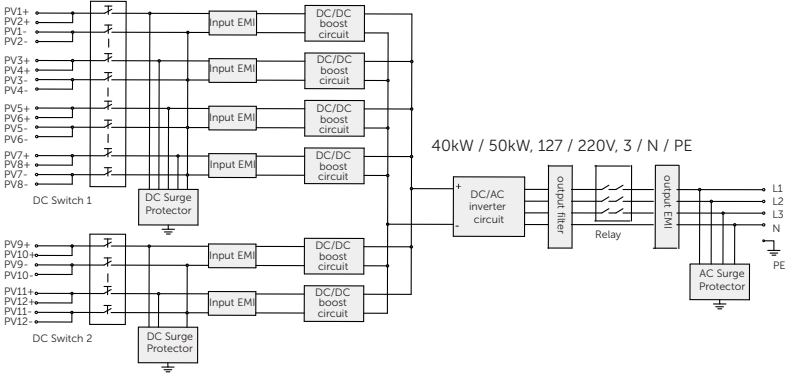

Figure 2-6 Circuit diagram for inverters of 40kW / 50kW, 127 / 220V, 3 / N / PE

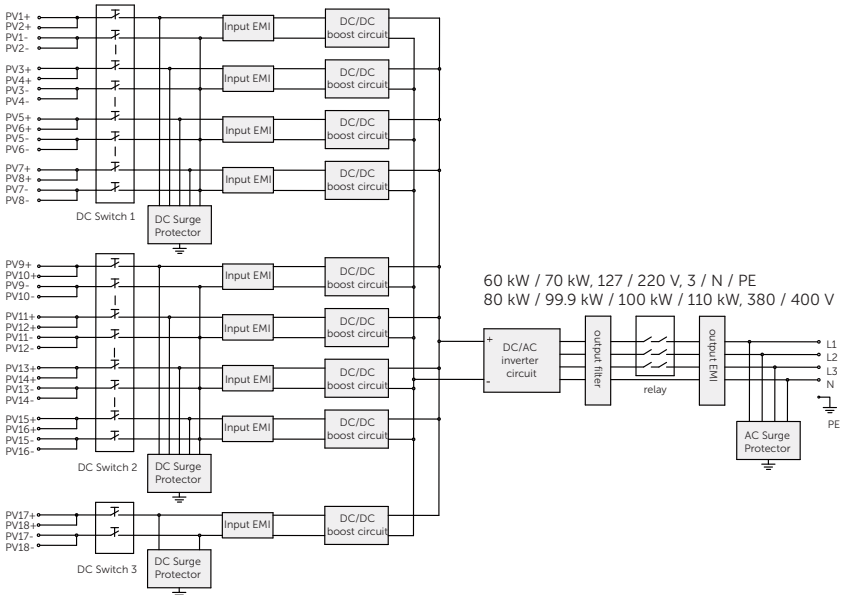

Figure 2-7 Circuit diagram for inverters of 60 kW / 70 kW, 127 / 220 V, 3 / N / PE  
80 kW / 99.9 kW / 100 kW / 110 kW, 380 / 400 V

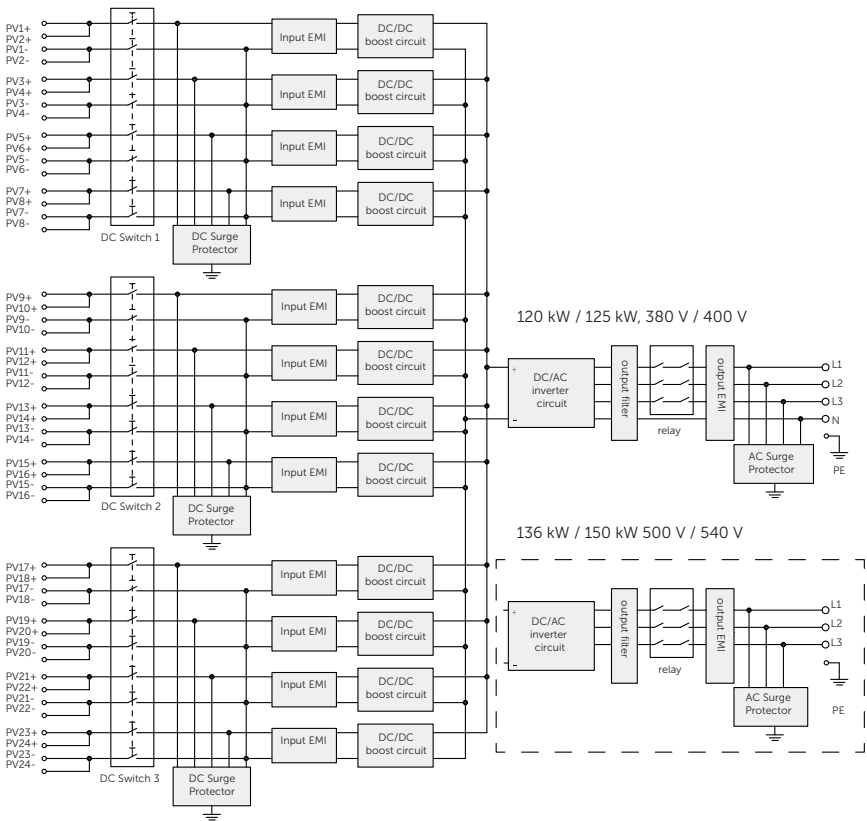

Figure 2-8 Circuit diagram for inverters of 120 kW / 125 kW, 380 V / 400 V and 136 kW / 150 kW 500 V / 540 V

## 2.5 Working State

State	Description
Waiting	<p>After powering on, the inverter enters the <b>Waiting</b> state.</p> <ul style="list-style-type: none"> <li>When the inverter detects sufficient photovoltaic input voltage, it enters the <b>Checking</b> state.</li> <li>If the inverter detects a fault, it enters the <b>Stop</b> state .</li> <li>Upon receiving an upgrade file, the inverter enters the <b>Upgrading</b> state to perform the upgrade process.</li> </ul>
Checking	<p>The inverter is initializing and synchronizing with the grid in the <b>Checking</b> state.</p> <ul style="list-style-type: none"> <li>The inverter performs a self-check, and upon passing, it enters the operating state .</li> <li>If the inverter detects a fault, it enters the <b>Stop</b> state.</li> <li>Upon receiving an upgrade file, the inverter enters the <b>Upgrading</b> state to perform the upgrade process.</li> </ul>
Running	<p>In <b>Running</b> state:</p> <ul style="list-style-type: none"> <li>The inverter converts the DC power from the photovoltaic strings into AC power and feeds it to the utility grid or load.</li> <li>The inverter tracks the maximum power point to optimize the output of the PV strings.</li> <li>If the inverter detects a fault, it enters the <b>Stop</b> state .</li> <li>Upon receiving an upgrade file, the inverter enters the <b>Upgrading</b> state to perform the upgrade process.</li> <li>If the inverter detects insufficient photovoltaic input, it enters the <b>Waiting</b> state and stops generating power.</li> </ul>
Stop	<p>When the inverter detects a fault, it enters the fault state. In the fault state:</p> <ul style="list-style-type: none"> <li>After troubleshooting, it enters the <b>Waiting</b> state .</li> <li>If the external communication interface receives a shutdown command, it will enter the <b>Stop</b> state. Once it receives a startup command from the external communication interface, it will return to the <b>Waiting</b> state.</li> <li>Upon confirming the upgrade after receiving an upgrade file, the inverter enters the <b>Upgrading</b> state to perform the upgrade process.</li> </ul>
Upgrading	<p>When the inverter firmware is being upgraded, it enters the <b>Upgrading</b> state. The upgrade process is as follows:</p> <ul style="list-style-type: none"> <li>Before the upgrade, the inverter will automatically shut down (transitioning from the previous state to the <b>Stop</b> state). It then enters the <b>Upgrading</b> state.</li> <li>After the upgrade is complete, the inverter will return to the <b>Stop</b> state. Once the inverter automatically powers on, it enters the <b>Waiting</b> state.</li> </ul>

# 3 Transportation and Storage

---

If the inverter is not put into use immediately, the transportation and storage requirements need to be met:

## Transportation

- Observe the caution signs on the packaging of inverter before transportation.
- Pay attention to the weight of the inverter. Carry the inverters by the required number of personnel as specified by local regulations. The gross weights of the X3-FORTH series inverters are as follows:
  - 40 kW / 50 kW inverters: 95.2 kg
  - 60 kW / 70 kW / 75 kW / 80 kW / 99.9 kW / 100 kW / 110 kW inverters: 97.7 kg
  - 120 kW / 125 kW / 136 kW / 150 kW inverters: 101.7 kg
- Wear protective gloves when carrying the equipment by hand to prevent injuries.
- When lifting up the inverter, hold the handle position and the bottom position of the carton. Keep the inverter horizontal in case of falling down.

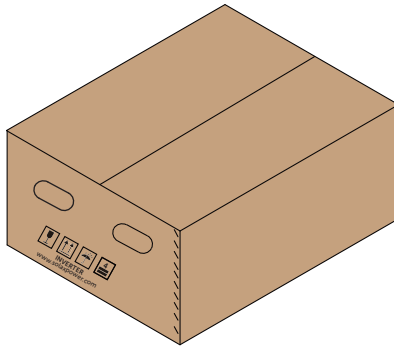

Figure 3-1 Caution signs on the packaging

 CAUTION!

If using the crane to lift up the inverter, before lifting:

- Ensure that the crane's load capacity is  $\geq 180$  kg, the lifting rope's load capacity is  $\geq 600$  kg, and the length is  $\geq 2.5$  m.
- Personnel involved in lifting operations must undergo relevant training and may only operate after passing the qualification assessment.
- If the working conditions on site do not meet requirements, professional evaluation is necessary.
- When used outdoors, it is recommended to operate the lifting equipment in clear and calm weather. Work should be suspended during adverse weather conditions such as heavy rain, snow, or strong winds.

During crane-lifting Process:

- It is strictly forbidden for unauthorized personnel to enter the lifting area, and no one is allowed to stand beneath the boom.
- Ensure that the crane is positioned correctly; long-distance lifting is not permitted.
- The angle between the two lifting ropes must be  $\leq 90^\circ$ .
- Lift and lower the equipment gently; when lowering, it should be smooth and steady to avoid impacting internal components.
- Dragging of steel wire ropes and lifting tools is prohibited, and collisions between equipment must be avoided.

### Storage

- The inverter must be stored indoors.
- Do not remove the original packaging material and check the outer packaging material regularly.
- Stack the inverter in accordance with the caution signs on the inverter carton to prevent their falling down and device damage. Do not place it upside down.

# 4 Preparation before Installation

## 4.1 Selection of Installation Location

The installation location selected for the inverter is quite critical in the aspect of the guarantee of device safety, service life and performance. It has the IP66 ingress protection, which allows it to be installed outdoor. The installation position shall be convenient for wiring connection, operation and maintenance.

### 4.1.1 Environment Requirement

- The ambient temperature:  $-25\text{ }^{\circ}\text{C}$  to  $+60\text{ }^{\circ}\text{C}$ .
- The relative humidity shall be between 0-100%RH.
- Do not install the inverter in areas where the altitude exceeds 4000 meters, as its performance will be derated above 3000 meters.
- Install the inverter in a well-ventilated environment for heat dissipation. It is recommended to install an awning over the inverter if it is installed on a support outdoor.
- Do not install the inverter in areas with flammable, explosive and corrosive materials or near antennas.
- Avoid direct sunlight, rain exposure and snow accumulation.

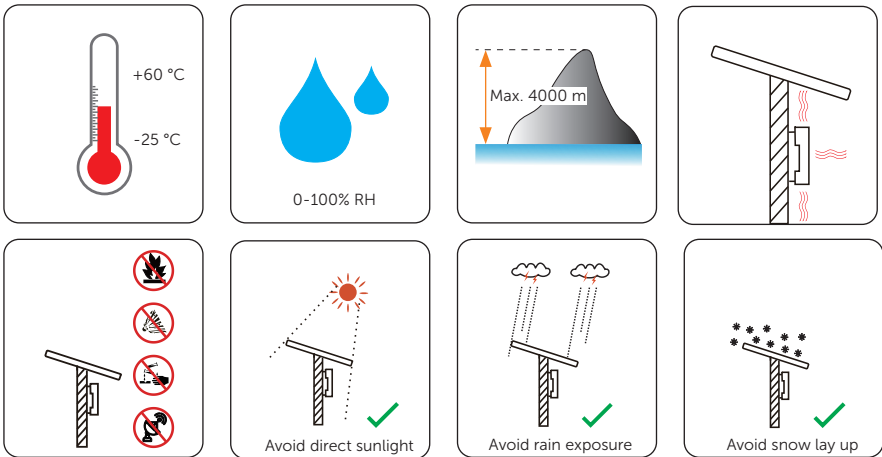

- Install the inverter at least 500 meters away from the coast and avoid sea breeze directly hit.

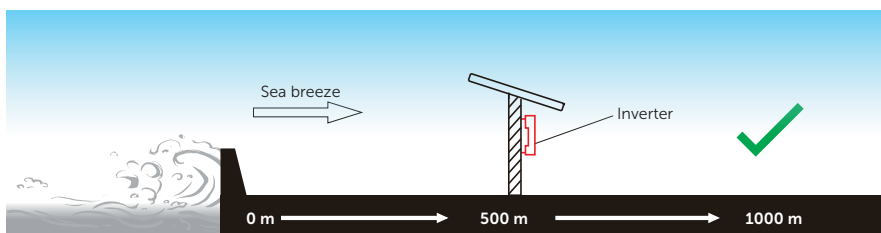

Figure 4-1 Recommended installation position

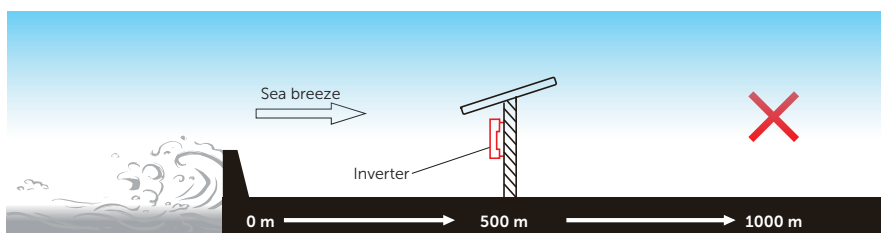

Figure 4-2 Incorrect installation position

### NOTICE!

- For outdoor installation, precautions against direct sunlight, rain exposure and snow accumulation are recommended.
- Exposure to direct sunlight raises the temperature inside the device. This temperature rise poses no safety risks, but may impact the device performance.

## 4.1.2 Installation Carrier Requirement

The installation carrier must be made of a non-flammable material, such as solid brick, concrete, etc. and be capable of supporting the weight of the inverter and suitable of the dimensions of the inverter. If the wall strength is not enough (such as wooden wall, the wall covered by a thick layer of decoration), it must be strengthened additionally.

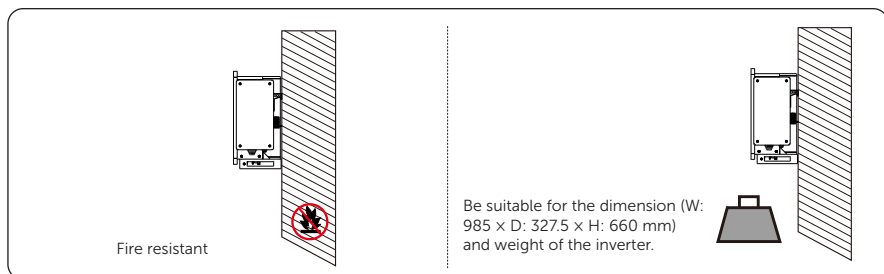

Inverter	40 kW	50 kW	60 kW	70 kW	75 kW	80 kW	99.9 kW	100 kW	110 kW	120 kW	125 kW	136 kW	150 kW
Weight (kg)	80.5		83						87				

Figure 4-3 Installation carrier requirement

### 4.1.3 Clearance Requirement

To guarantee proper heat dissipation and ease of disassembly, the minimum space around the inverter must meet the standards indicated below.

For installations with multiple inverters, make sure to leave a minimum space of 30 cm on the sides and 60 cm above and below each inverter. In areas with high ambient temperatures, increase the clearances between the inverters and provide adequate fresh air ventilation if feasible.

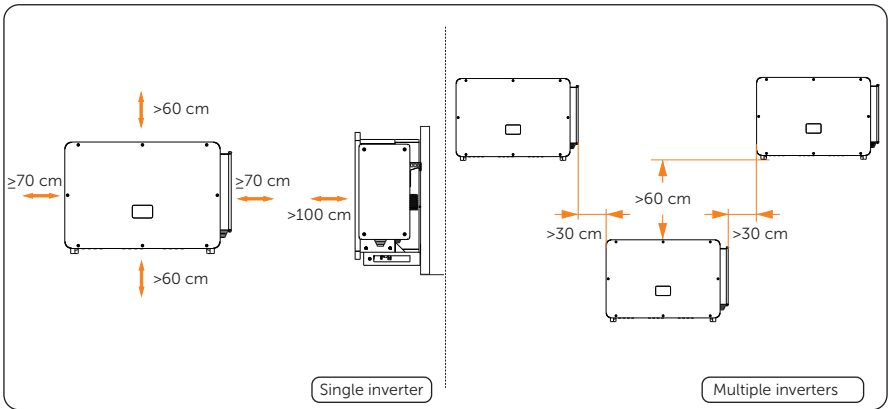
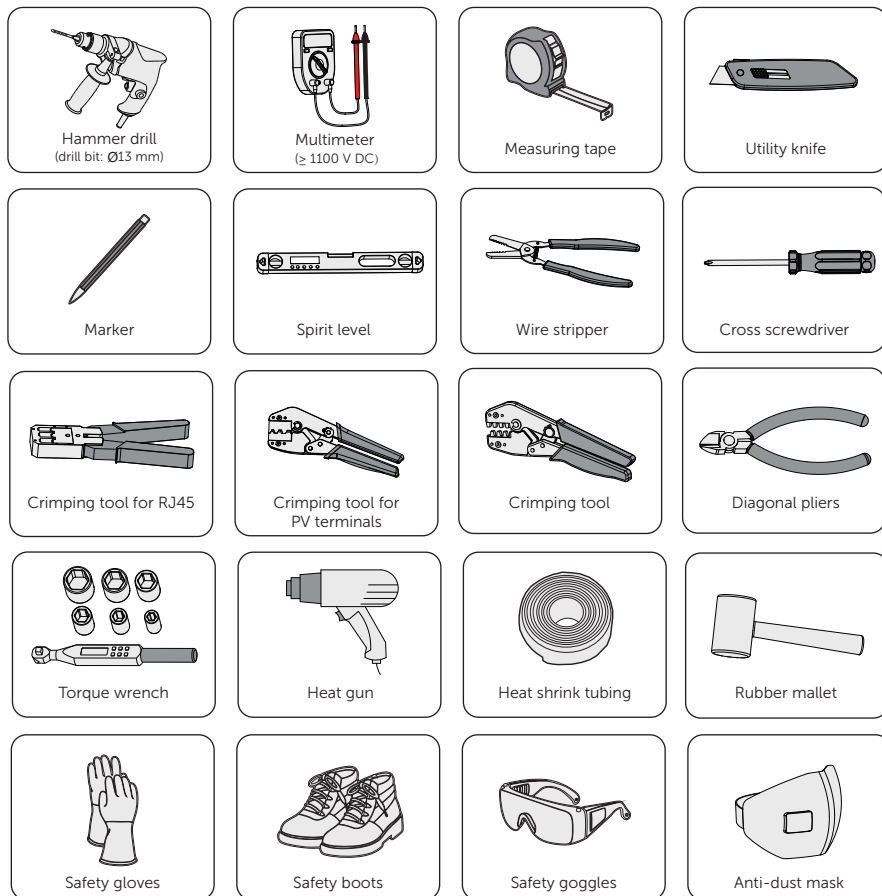

Figure 4-4 Clearance requirement for single and multiple inverters

## 4.2 Tools Requirement

Installation tools include but are not limited to the following recommended ones. If necessary, use other auxiliary tools on site. Please note that the tools used must comply with local regulations.



### 4.3 Additionally Required Materials

Table 4-1 Additionally required wires

No.	Required Material	Type	Conductor Cross-Section	Cable Length
1	PV cable	Dedicated PV wire, copper, complying with 1,500 V standard	4-6 mm <sup>2</sup>	≤200 m
2	AC cable (40 ~ 125 kW)	Five-core copper wire	70 mm <sup>2</sup> ~ 240 mm <sup>2</sup>	≤200 m
	AC cable (40 ~ 125 kW)	Five-core aluminium wire	95 mm <sup>2</sup> ~ 240 mm <sup>2</sup>	≤200 m
3	AC cable (136 ~ 150 kW)	Four-core copper wire	70 mm <sup>2</sup> ~ 240 mm <sup>2</sup>	≤200 m
	AC cable (136 ~ 150 kW)	Four-core aluminium wire	95 mm <sup>2</sup> ~ 240 mm <sup>2</sup>	≤200 m
4	Communication cable	Network cable CAT5 or better	0.5 mm <sup>2</sup> ~ 0.75 mm <sup>2</sup>	≤200 m
	Communication terminal	ENY0512 nylon terminal for 0.5 mm <sup>2</sup> / 22 AWG conductor ENY7512 nylon terminal for 0.75 mm <sup>2</sup> / 20 AWG conductor		
5	Additional PE cable	Conventional yellow and green wire	35 mm <sup>2</sup> ~ 120 mm <sup>2</sup>	≤200 m
6	M10 × L80 expansion bolt kit × 4	For wall-mounting	/	/

Inverter	40 kW	50 kW	60 kW	70 kW	75 kW	80 kW	99.9 kW
AC breaker	150 A	200 A	250 A	250 A	250 A	200 A	250 A

Inverter	100 kW	110 kW	120 kW	125 kW	136 kW	150 kW
AC breaker	250 A	250 A	250 A	250 A	200 A	250 A

# 5 Unpacking and Inspection

---

## 5.1 Unpacking

- The inverter undergoes 100% testing and inspection before delivery. However, damages may still occur during transportation. Before unpacking, please carefully check the external packaging for any signs of damage, such as punctures or cracks.
- Unpacking the inverter according to the following figure.

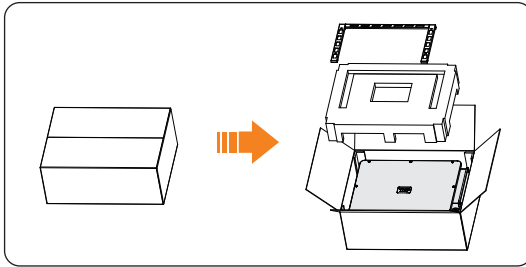

Figure 5-1 Unpacking the inverter

- Properly handle all the packaging materials in case they may be reused for storage and transportation of the inverter in the future.
- Upon opening the package, check whether the inverter is intact and whether all accessories are included. If any damage is found or any parts are missing, contact your dealer immediately.

## 5.2 Scope of Delivery

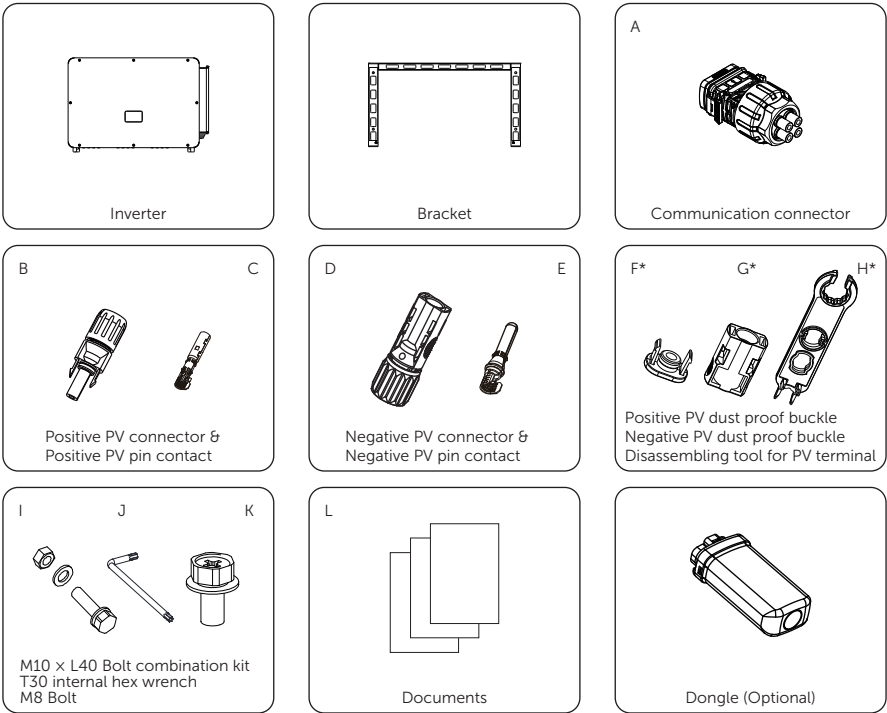

Table 5-1 Packing list

Item	Description	Quantity	Remark
/	Inverter	1 pc	
/	Bracket	1 pc	
A	Communication connector	1 pc	
B	Positive PV connector	12 pairs for 40 ~ 50 kW 18 pairs for 60 ~ 110 kW	
C	Positive PV pin contact	24 pairs for 120 ~ 150 kW	
D	Negative PV connector	12 pairs for 40 ~ 50 kW 18 pairs for 60 ~ 110 kW	
E	Negative PV pin contact	24 pairs for 120 ~ 150 kW	

Item	Description	Quantity	Remark
F*	Positive PV dust proof buckle	6 pairs for 40-50 kW 9 pairs for 60-110 kW 12 pairs for 120-150 kW	Used to install on the positive/negative PV input port when the PV is not connected
G*	Negative PV dust proof buckle		
H*	Disassembling tool for PV terminal	1 pc	Used to remove the dust proof buckle or PV connector
I	M10 × L40 Bolt combination kit	4 pcs	Used to fix the bracket
J	T30 internal hex wrench	1 pc	Used to open the AC wiring box
K	M8 Bolt	2 pcs	Used to fix the inverter
L	Documents	/	
/	Dongle (Optional)	1 pc	

#### NOTICE!

- Refer to the actual delivery for the optional accessories.
- Please purchase OT terminals separately.
- For some counties or regions, F\*, G\* and H\* are not included in the packing list. Please refer to the actual delivery.

# 6 Mechanical Installation

## WARNING!

- Only qualified personnel are allowed to perform the mechanical installation in accordance with local laws and regulations.
- Check the existing power cables or other piping in the wall to prevent electric shock or other damage.
- Use insulated tools and wear personal protective equipment throughout the installation and maintenance process.

## CAUTION!

- During installation, always be cautious about the weight of the inverter. Improper lifting or dropping of the inverter may result in personal injury.

## NOTICE!

- Install the inverter at a maximum back tilt of 5 degrees and avoid it being forward tilted, side tilted, or upside down.

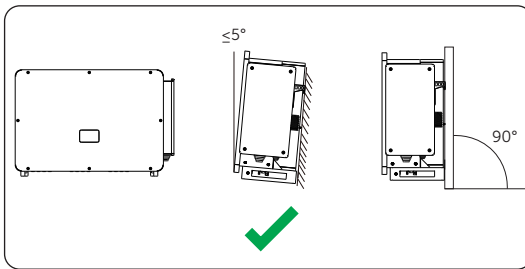

Figure 6-1 Correct installation

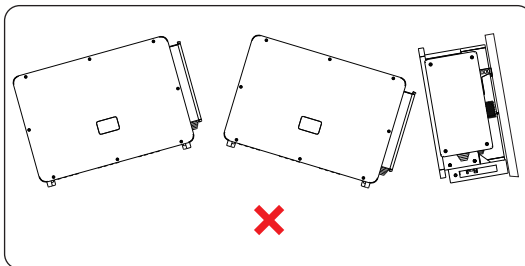

Figure 6-2 Incorrect installation

## 6.1 Dimensions for mounting

Before installation, check the dimensions of the bracket and ensure that enough space is reserved for the installation and heat dissipation of the entire system.

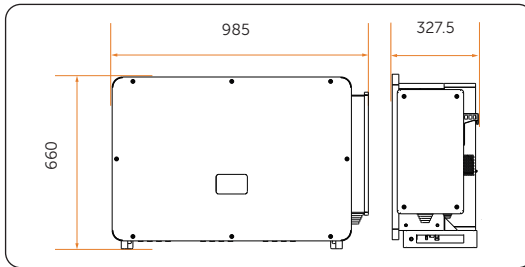

Figure 6-3 Dimensions 1 (Unit: mm)

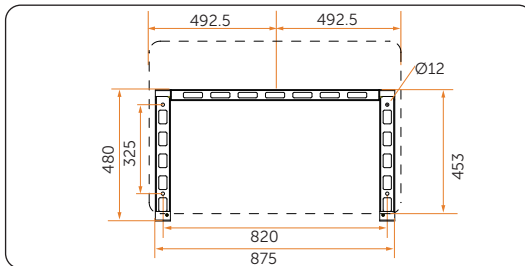

Figure 6-4 Dimensions 2 (Unit: mm)

## 6.2 Installation procedures

### Stand-mounting

**Step 1:** Find out the four M10 × L40 bolt combination kit (part I), bracket and two M8 bolts (part K) from the accessory box. Use the bracket as a template to mark the positions for 4 drilling holes on the stand with a spirit level and marker.

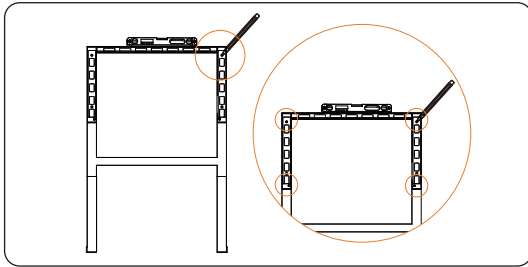

Figure 6-5 Marking the holes

**Step 2:** Drill holes with  $\varnothing 12$  drill bit in accordance with the mark.

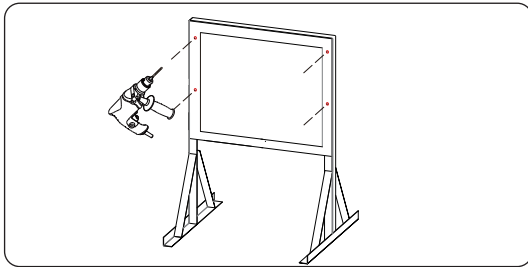

Figure 6-6 Drilling holes

**Step 3:** Pre-install the bracket on the stand and tighten M10 x L40 screws.

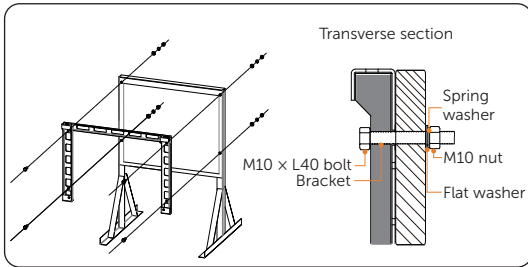

Figure 6-7 Transverse section

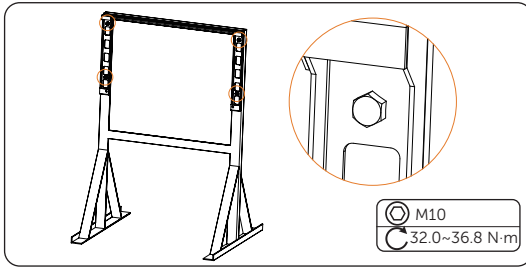

Figure 6-8 Tightening the screws

**Step 4:** Lift the inverter using one of two methods: four installers or lifting equipment to lift up the inverter (please select the appropriate lifting method based on the actual appearance of the equipment).

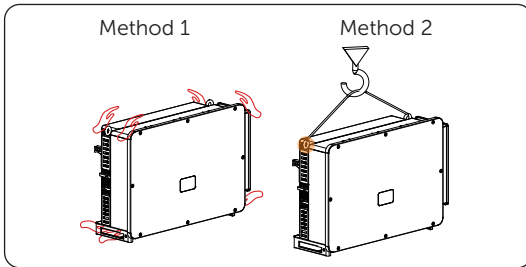

Figure 6-9 Lifting the inverter

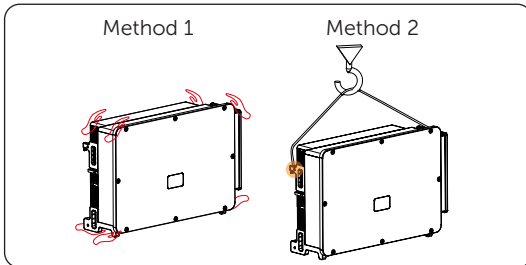

Figure 6-10 Lifting the inverter

**CAUTION!**

When lifting the inverter using the second method, before lifting:

- Ensure that the crane's load capacity is  $\geq 180$  kg, the lifting rope's load capacity is  $\geq 600$  kg, and the length is  $\geq 2.5$  m.
- Personnel involved in lifting operations must undergo relevant training and may only operate after passing the qualification assessment.
- If the working conditions on site do not meet requirements, professional evaluation is necessary.
- When used outdoors, it is recommended to operate the lifting equipment in clear and calm weather. Work should be suspended during adverse weather conditions such as heavy rain, snow, or strong winds.

During the Lifting Process,:

- It is strictly forbidden for unauthorized personnel to enter the lifting area, and no one is allowed to stand beneath the boom.
- Ensure that the crane is positioned correctly; long-distance lifting is not permitted.
- The angle between the two lifting ropes must be  $\leq 90^\circ$ .
- Lift and lower the equipment gently; when lowering, it should be smooth and steady to avoid impacting internal components.
- Dragging of steel wire ropes and lifting tools is prohibited, and collisions between equipment must be avoided.

**Step 5:** Hang the inverter on the bracket and secure the inverter on both sides with M8 bolts (part K).

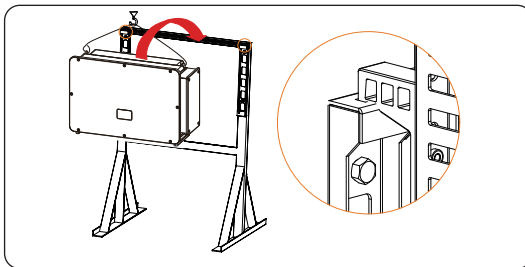

Figure 6-11 Securing the inverter

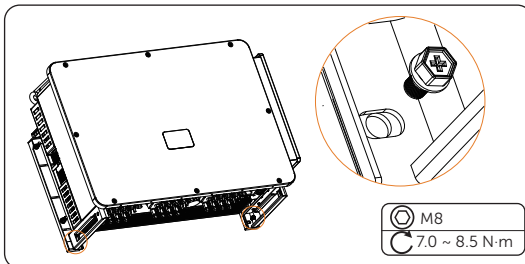

Figure 6-12 Locking the inverter

## Wall-mounting

- Step 1:** Find out the bracket and M8 bolts (part K) from the accessory box. Prepare M10 × L80 iron expansion combination in advance. Please kindly note that M10 × L80 screws are not in the accessory box. Use the bracket as a template for marking the positions of drilling holes on the wall with a spirit level and marker.

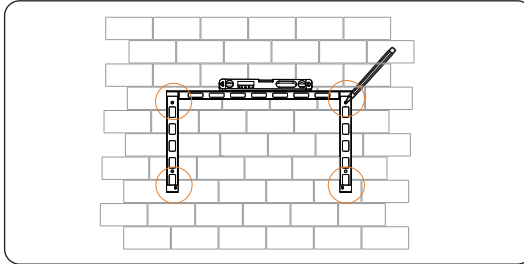

Figure 6-13 Marking the holes

- Step 2:** Use  $\varnothing 13$  drill to drill holes in accordance with the mark. The depth of the holes shall be at least 65 mm.

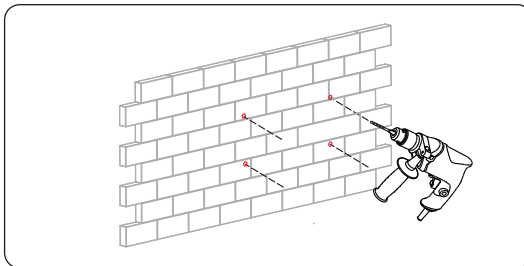

Figure 6-14 Drilling holes

- Step 3:** Insert the expansion screws into the holes, hang the bracket on the screw and fix it with a nut.

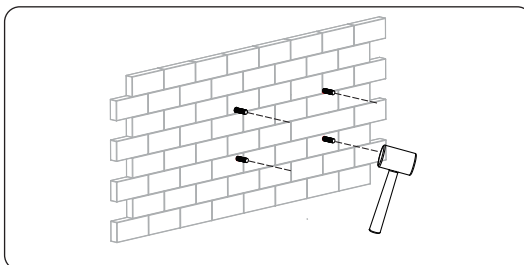

Figure 6-15 Inserting the expansion screws

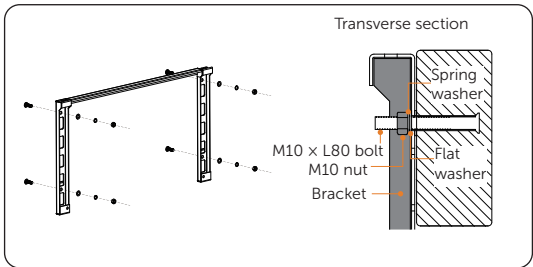

Figure 6-16 Transverse section

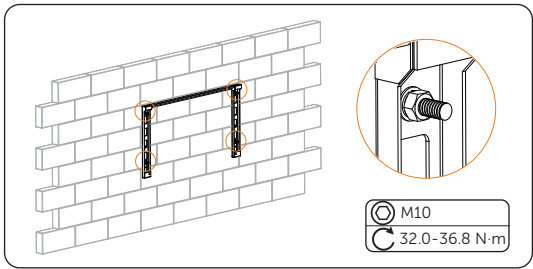

Figure 6-17 Securing the bracket

**Step 4:** Lift the inverter using one of two methods: four installers or lifting equipment to lift up the inverter (please select the appropriate lifting method based on the actual appearance of the equipment).

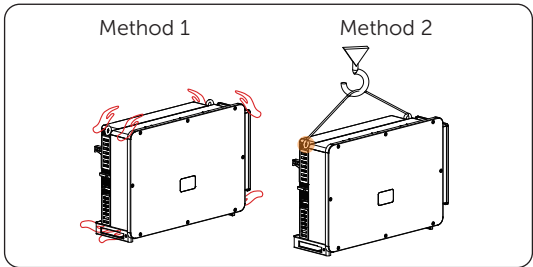

Figure 6-18 Lifting the inverter

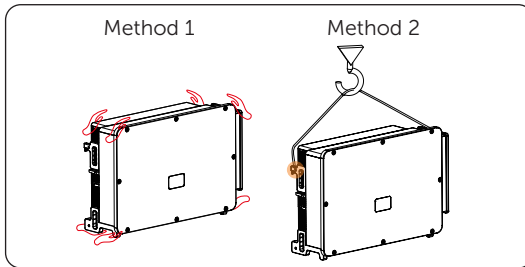

Figure 6-19 Lifting the inverter

### ⚠ CAUTION!

When lifting the inverter using the second method, before lifting:

- Ensure that the crane's load capacity is  $\geq 180$  kg, the lifting rope's load capacity is  $\geq 600$  kg, and the length is  $\geq 2.5$  m.
- Personnel involved in lifting operations must undergo relevant training and may only operate after passing the qualification assessment.
- If the working conditions on site do not meet requirements, professional evaluation is necessary.
- When used outdoors, it is recommended to operate the lifting equipment in clear and calm weather. Work should be suspended during adverse weather conditions such as heavy rain, snow, or strong winds.

During the Lifting Process,:

- It is strictly forbidden for unauthorized personnel to enter the lifting area, and no one is allowed to stand beneath the boom.
- Ensure that the crane is positioned correctly; long-distance lifting is not permitted.
- The angle between the two lifting ropes must be  $\leq 90^\circ$ .
- Lift and lower the equipment gently; when lowering, it should be smooth and steady to avoid impacting internal components.
- Dragging of steel wire ropes and lifting tools is prohibited, and collisions between equipment must be avoided.

**Step 5:** Hang the inverter on the bracket and secure it on the bracket with M8 bolts.

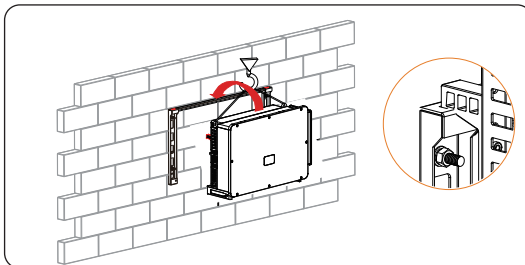

Figure 6-20 Hanging the inverter

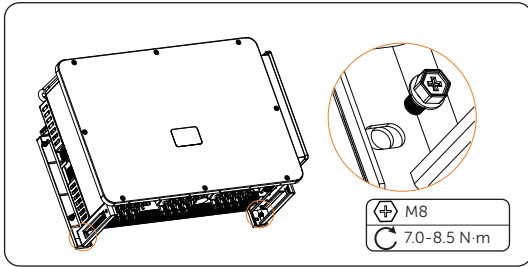

Figure 6-21 Securing the inverter

# 7 Electrical Connection

## DANGER!

- Before electrical connection, make sure the DC switch and AC breaker are disconnected. Otherwise, the high voltage may cause electric shock, resulting in severe personal injuries or even death.

## WARNING!

- Only qualified personnel are allowed to perform the electrical connection following local laws and regulations.
- Strictly follow the instructions of this manual or other related documentation for electrical connection. Inverter damages caused by incorrect wiring are not covered by the warranty.
- Use insulated tools and wear personal protective equipment throughout the electrical connection process.

## 7.1 Overview of Electrical Connection

### 7.1.1 Terminals of Inverter

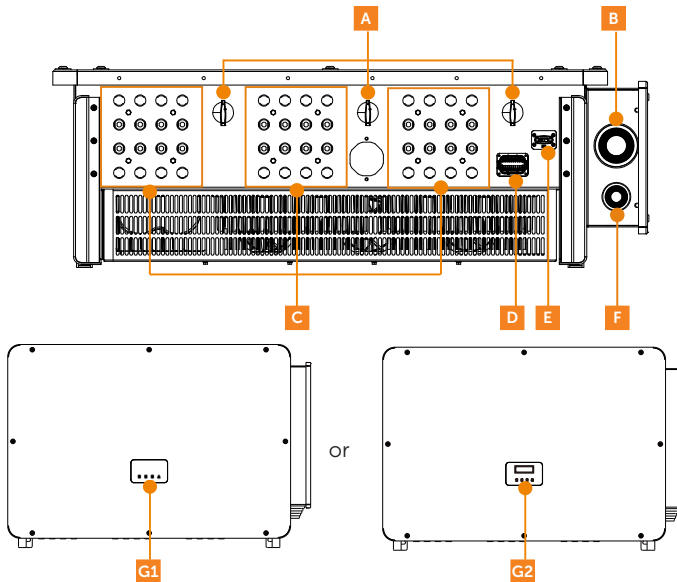

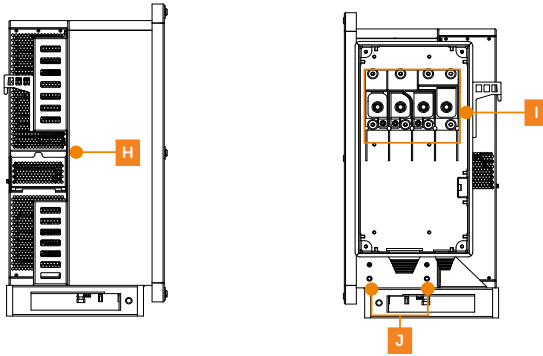

Figure 7-1 Terminals of inverter

Table 7-1 Description of terminals

Item	Description	Remarks
A	DC switch	
B	AC Port	
C	PV terminals	
D	RS485 / Meter / DRM connector	(Optional)
E	WiFi / LAN / 4G dongle connector	(Optional)
F	Grounding port	(To be used only when connecting with a single-core cable for AC, thus requiring a separate PE cable for grounding).
G1	LED indicator	
G2	LCD panel	(Optional)
H	Fan support	(Cooling fan inside)
I	AC terminals	
J	Grounding connector	

## 7.1.2 Cable Connections of Inverter

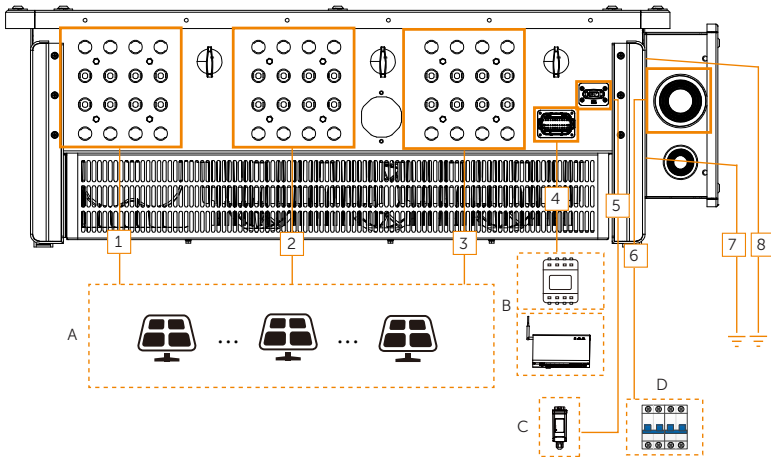

Figure 7-2 Cable connections of inverter

Table 7-2 Descriptions of connected part

Item	Part	Description	Source
A	PV module	A PV string is composed of the PV modules connected in series. The number of input PV strings varies in accordance with different models.	Prepared by user
B	(Optional) SolaX communication device	SolaX DataHub is supported. Select the device as needed.	Purchased from SolaX
	(Optional) Meter	The inverter can be paired with meter to monitor system data and control grid feed power.	Purchased from SolaX
C	Upgrading USB disk	USB disk with update firmware file can be plugged into the upgrading port when the inverter is in normal status.	Prepared by user
	(Optional) Monitoring dongle	Only SolaX monitoring dongle supported.	Purchased from SolaX
D	AC breaker	Select an appropriate AC breaker according to the local regulations to ensure the inverter can be securely disconnected from the grid when an emergency occurs. Refer to <a href="#">"4.3 Additionally Required Materials"</a> for the recommended specifications.	Prepared by user

Table 7-3 Descriptions of cables

Item	Cable	Type and specifications	Source
1-3	PV cable		
4	Communication cable	Refer to "4.3 Additionally Required Materials" .	Prepared by user
6	AC cable		
7-8	PE cable		

## 7.2 PE Connection

The uncharged metal parts in the photovoltaic power generation system, including the photovoltaic substrate bracket and the metal shell of the inverter, should be reliably grounded. The grounding part of multiple inverters and photovoltaic array shall be connected to the same grounding bus to establish reliable equipotential connection.

### PE connection procedures

**Step 1:** Select OT copper terminal and  $35 \sim 120 \text{ mm}^2$  yellow and green conductor with proper length by diagonal pliers. Use wire stripper to strip the insulation layer of the conductor end. The stripped length shall be as shown below.

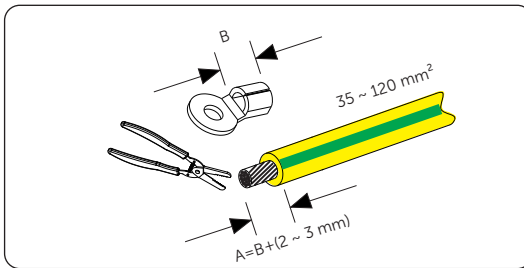

Figure 7-3 Stripping the PE cable

**Step 2:** Tighten the stripped end and pull the heat shrink tubing over the grounding cable. The heat shrink tubing must be at below cable section.

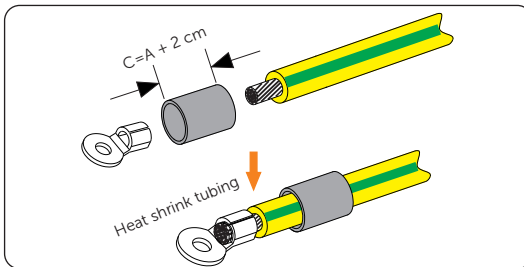

Figure 7-4 Installing the tubing and OT terminal

**Step 3:** Crimp it with crimping tool, pull the heat-shrink tubing over the stripped section of the OT terminal and use a heat gun to shrink it so that it can be firmly contacted with the terminal.

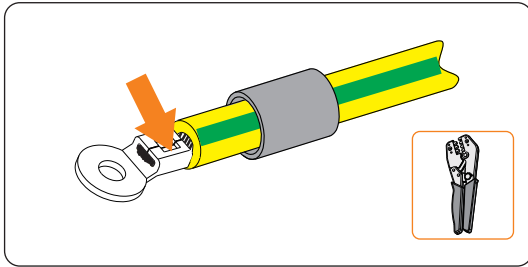

Figure 7-5 Crimping the cable

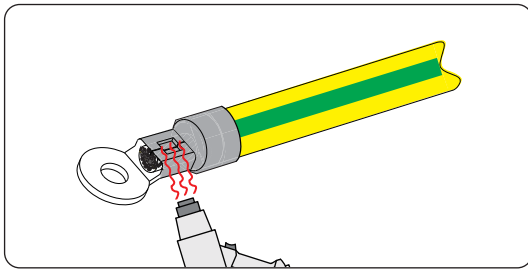

Figure 7-6 Shrinking the tubing

**Step 4:** Remove the screws from the shell and connect the grounding cable to the inverter and fix it with torque 7.0 ~ 8.5 N·m.

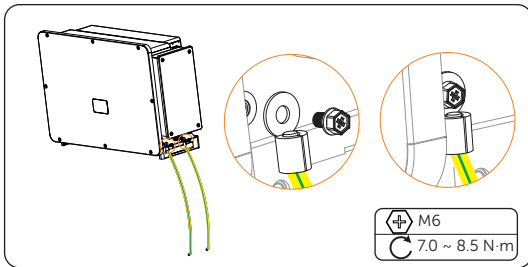

Figure 7-7 Securing the PE cable

**WARNING!**

- Be sure the ground wire must be connected!

## 7.3 AC Side Connection

### WARNING!

- Ensure electrical connection design meets local national and local standards.
- The PE wire (ground wire) of the inverter must be reliably grounded.
- Disconnect the circuit breaker or fuse of inverter and grid connection access point.

### NOTICE!

- Before connecting the inverter to the grid, approval must be received by local utility as required by national and state interconnection regulations.
- It is recommended to add a circuit breaker or fuse on the AC side, whose specification is more than 1.25 times of rated AC output current.
- 70 ~ 240 mm<sup>2</sup> copper wire is recommended. If aluminium wire is needed, please check the requirements of the wire and then purchase by yourself.
- Use copper terminal for copper wire, use copper aluminium terminal for aluminium wire, not aluminium terminal directly.
- 40 kW ~ 70 kW / 75 kW ~ 120 kW inverter adopts 4-pin AC terminal; 136 kW / 150 kW inverter adopts 3-pin AC terminal.

### Wiring procedures

#### Step 1: Make the AC cable

- Select the appropriate OT terminal and blue, red and yellow and green cable with proper length. Use wire stripper to strip the insulation layer of the AC cable end. The stripped insulation layer shall be 2 ~ 3 mm longer than "C" part of OT terminal.

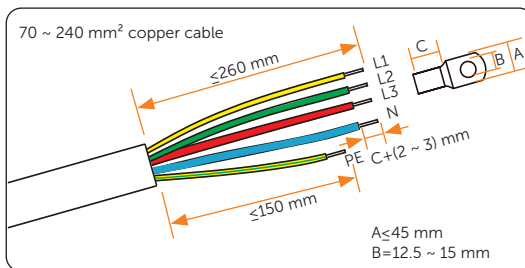

Figure 7-8 Stripping the AC cable (40 kW ~ 70 kW / 75 kW ~ 125 kW inverter)

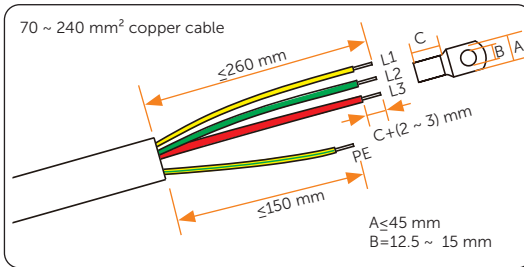

Figure 7-9 Stripping the AC cable (136 kW ~ 150 kW inverter)

- b. Pull the heat-shrink tubing over AC cable. Insert the stripped section into OT terminal, crimp with crimping tool and pull the heat shrink tubing over the crimped section of OT terminal. Use the heat gun to shrink it so that they are in firm contact with OT terminal.

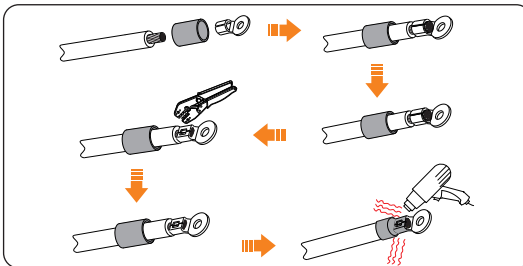

Figure 7-10 Crimping the OT terminals

- c. Open the cover of the wiring box.

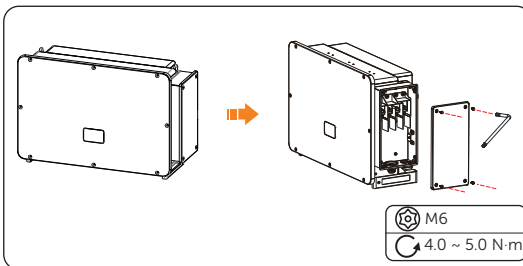

Figure 7-11 Installing the ferrite core (40 kW ~ 70 kW / 75 kW ~ 125 kW inverter)

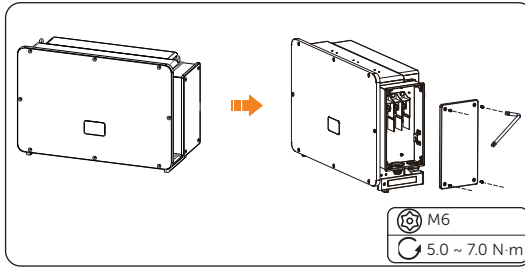

Figure 7-12 Installing the ferrite core (136 kW-150 kW inverter)

**Step 2:** Connect the AC cable to the inverter

- a. Disassemble the M12 nut

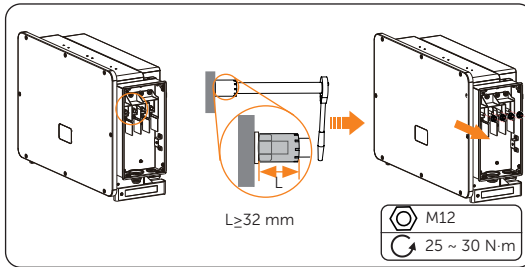

Figure 7-13 Disassembling the M12 nut (40 kW ~ 70 kW / 75 kW ~ 125 kW inverter for example)

- b. Use a utility knife to cut off the pagoda-shaped coil in accordance with actual cable size, route the AC cable through the pagoda-shaped coil, and connect it to the AC terminals L1, L2, L3 and N in turn, and tighten it with torque wrench (with the torque of 25 ~ 30 N·m).

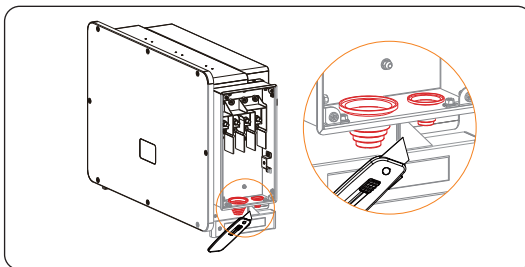

Figure 7-14 Cutting off the pagoda-shaped coil

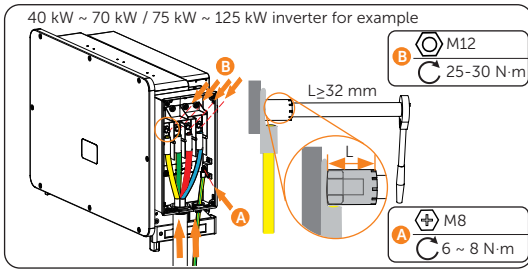

Figure 7-15 Tightening PE cable before connecting L and N cable

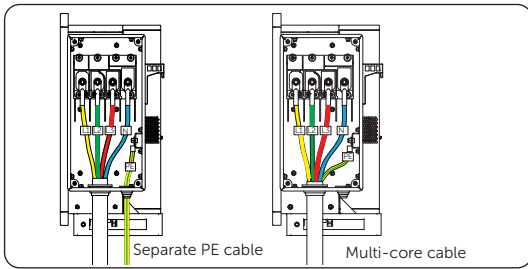

Figure 7-16 Wiring connection diagrams for PE cable (40 kW ~ 70 kW / 75 kW ~ 125 kW inverter)

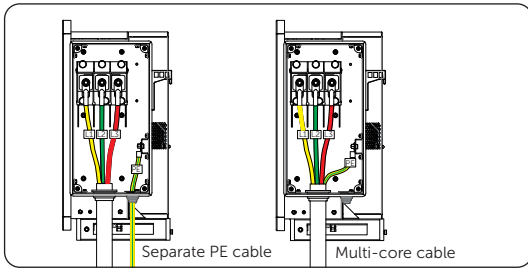

Figure 7-17 Wiring connection diagrams for PE cable (136 kW ~ 150 kW inverter)

- c. Re-install the cover of the wiring box and tighten it with screws (with the torque of 5 ~ 7 N·m).

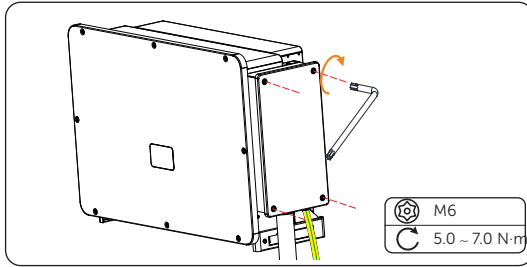

Figure 7-18 Re-installing the cover

**NOTICE!**

- Plug the cut pagoda-shaped coil with fireproof mud before closing AC wiring box.
- Prepare your own fireproof mud that meets local environmental standards.

## 7.4 PV Connection

### ! WARNING!

- Before connecting the inverter, ensure that the open-circuit voltage of the PV string does not exceed 1100 V under any circumstances (pay special attention to the impact of the low-temperature VOC temperature coefficient of the modules); otherwise, it may damage the inverter.
- Do not ground the positive or negative terminal of the PV string, as this can cause severe damage to the inverter. Any equipment damage resulting from this is not covered under the device warranty.
- The voltage difference between different MPPTs should be less than 150 V.
- Please turn off all DC switches before connecting the PV strings!
- Before connecting the PV strings to the inverter, ensure that the positive and negative terminals of the PV strings correspond to the positive and negative terminals of the inverter, and then insert them into the PV terminal.
- During grid-connected operation of the inverter, maintenance operations on the PV input cables, such as inserting or removing a PV string or a component within a PV string, are strictly prohibited. Otherwise, it may lead to electric shock or the risk of arcing and fire.
- Parallel connection between different MPPTs is not allowed.

### NOTICE!

- Please ensure that the output of the photovoltaic modules is well insulated from the ground.
- PV strings connected to the same MPPT must use the same model and the same number of photovoltaic panels.

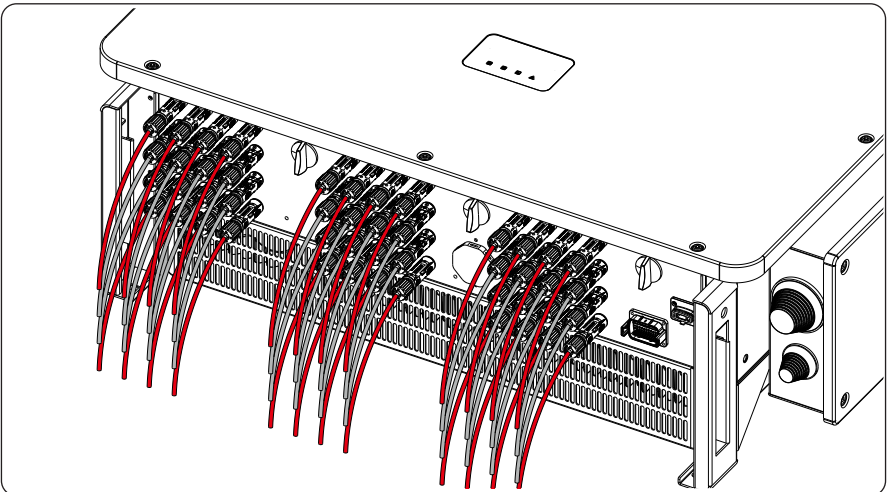

Figure 7-1 Inverter PV full connection diagram  
(120 kW, 125 kW, 136 kW and 150 kW inverter for example)

### 7.4.1 PV Terminal Connection Recommendations for 9 MPPT Models

The inverter is equipped with three DC switches: DC SWITCH 1 controls the DC terminals PV1 to PV8, DC SWITCH 2 controls the DC terminals PV9 to PV16, and DC SWITCH 3 controls the DC terminals PV17 to PV18.

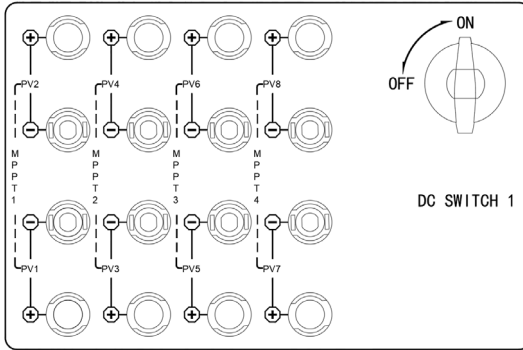

Figure 7-2 DC SWITCH 1 controls the DC terminals PV1 ~ PV8

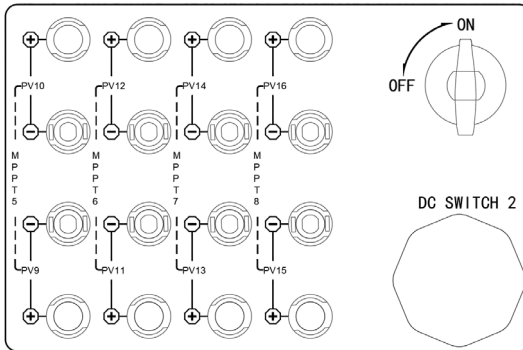

Figure 7-3 DC SWITCH 2 controls the DC terminals PV9 ~ PV16

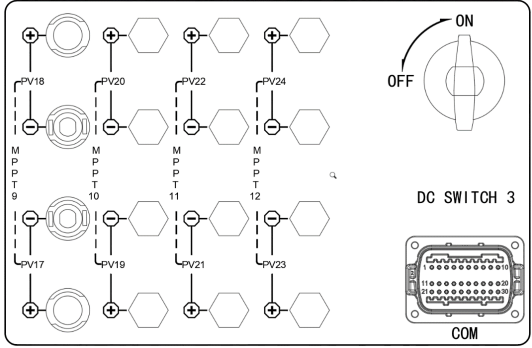

Figure 7-4 DC SWITCH 3 controls the DC terminals PV17 ~ PV18

### PV Terminal Configuration

When the PV strings are not fully connected, the recommended selection for the PV terminals are as follows:

- PV strings should be evenly distributed across the three DC switches controlling the PV terminals.
- Maximize the number of MPPT connections.

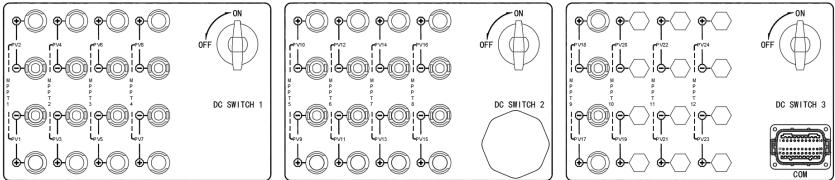

Figure 7-5 Configuration for 1 String Input: Connect to any even terminal.

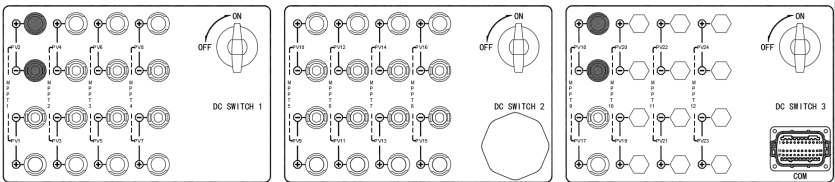

Figure 7-6 Configuration for 2 Strings Input: Connect to PV2, PV18 terminals.

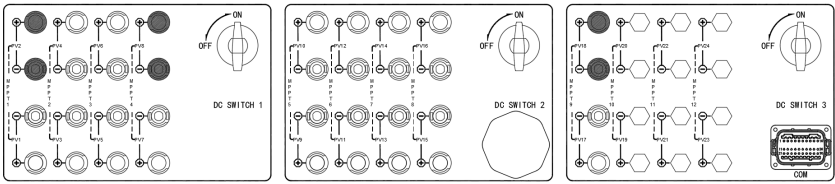

Figure 7-7 Configuration for 3 Strings Input: Connect to PV2, PV8, PV18 terminals.

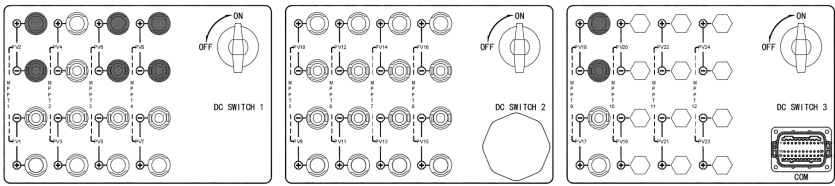

Figure 7-8 Configuration for 4 Strings Input: Connect to PV2, PV6, PV8, PV18 terminals.

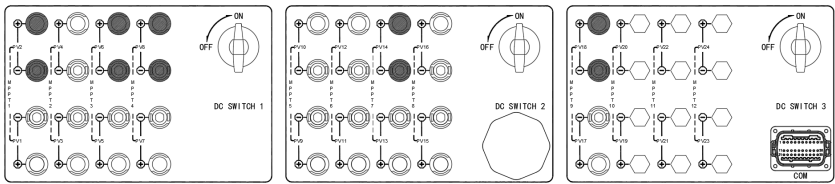

Figure 7-9 Configuration for 5 Strings Input: Connect to PV2, PV6, PV8, PV14, PV18 terminals

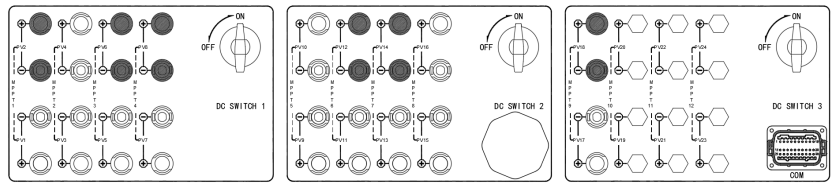

Figure 7-10 Configuration for 6 Strings Input: Connect to PV2, PV6, PV8, PV12, PV14, PV18 terminals.

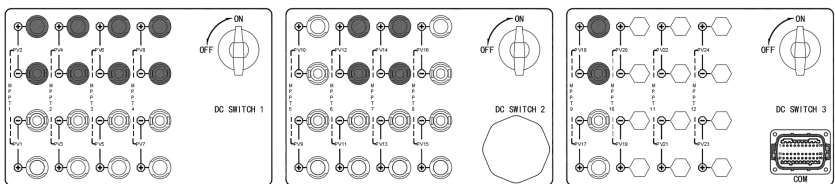

Figure 7-11 Configuration for 7 Strings Input: Connect to PV2, PV4, PV6, PV8, PV12, PV14, PV18 terminals.

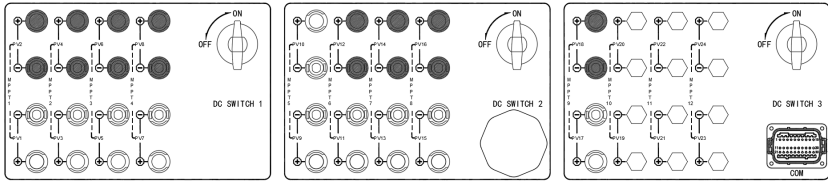

Figure 7-12 Configuration for 8 Strings Input: Connect to PV2, PV4, PV6, PV8, PV12, PV14, PV16, PV18 terminals.

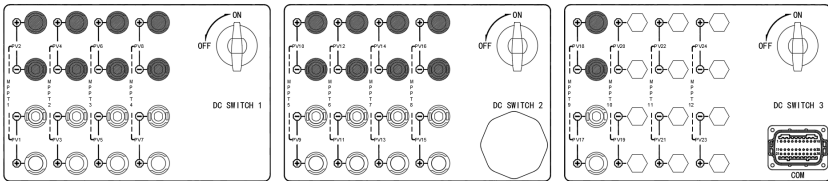

Figure 7-13 Configuration for 9 Strings Input: Connect to PV2, PV4, PV6, PV8, PV10, PV12, PV14, PV16, PV18 terminals.

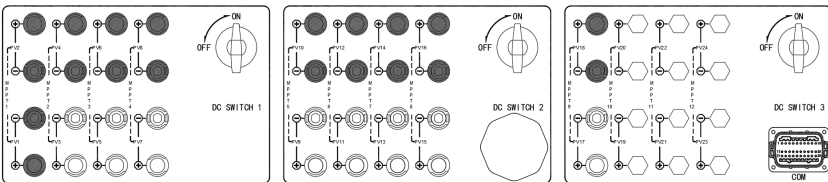

Figure 7-14 Configuration for 10 Strings Input: Connect to PV1, PV2, PV4, PV6, PV8, PV10, PV12, PV14, PV16, PV18 terminals.

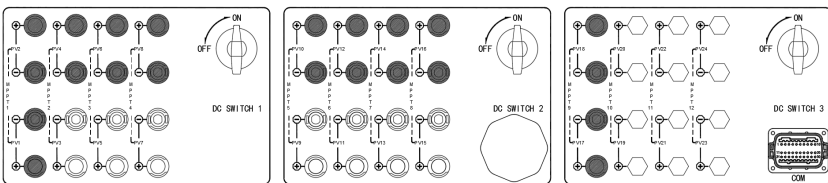

Figure 7-15 Configuration for 11 Strings Input: Connect to PV1, PV2, PV4, PV6, PV8, PV10, PV12, PV14, PV16 ~ PV18 terminals.

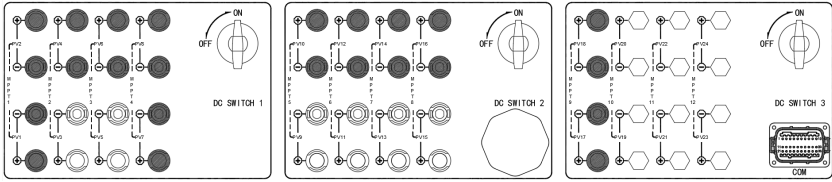

Figure 7-16 Configuration for 12 Strings Input: Connect to PV1, PV2, PV4, PV6 ~ PV8, PV10, PV12, PV14, PV16 ~ PV18 terminals.

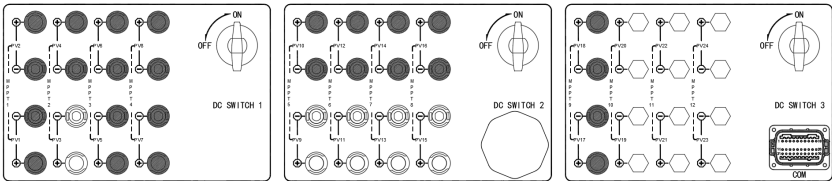

Figure 7-17 Configuration for 13 Strings Input: Connect to PV1, PV2, PV4 ~ PV8, PV10, PV12, PV14, PV16 ~ PV18 terminals.

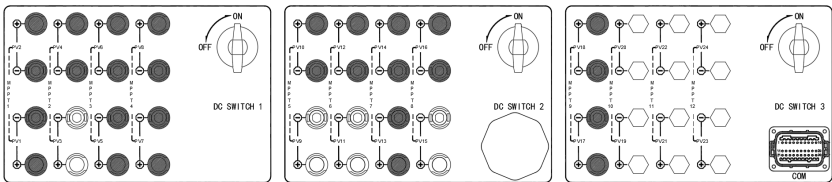

Figure 7-18 Configuration for 14 Strings Input: Connect to PV1, PV2, PV4 ~ PV8, PV10, PV12 ~ PV14, PV16 ~ PV18 terminals.

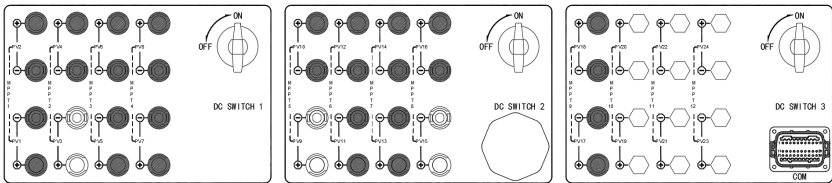

Figure 7-19 Configuration for 15 Strings Input: Connect to PV1, PV2, PV4 ~ PV8, PV10 ~ PV14, PV16 ~ PV18 terminals.

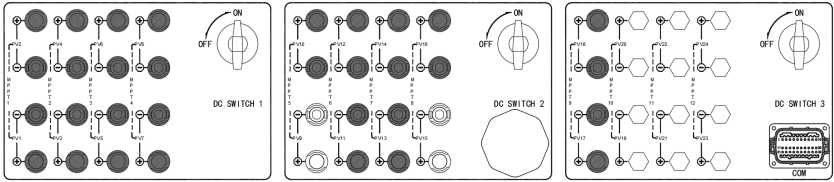

Figure 7-20 Configuration for 16 Strings Input: Connect to PV1 ~ PV8, PV10 ~ PV14, PV16 ~ PV18 terminals.

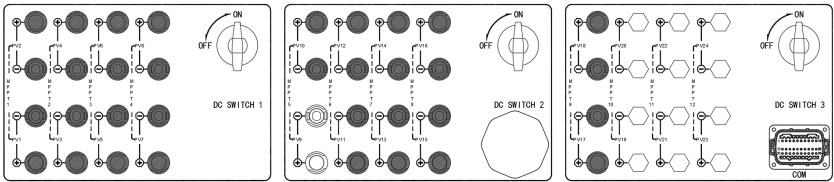

Figure 7-21 Configuration for 17 Strings Input: Connect to PV1 ~ PV8, PV10 ~ PV18 terminals

### 7.4.2 PV Terminal Connection Recommendations for 12 MPPT Models

The inverter is configured with three DC switches: DC SWITCH 1 controls the DC terminals PV1 to PV8, DC SWITCH 2 controls the DC terminals PV9 to PV16, and DC SWITCH 3 controls the DC terminals PV17 to PV24.

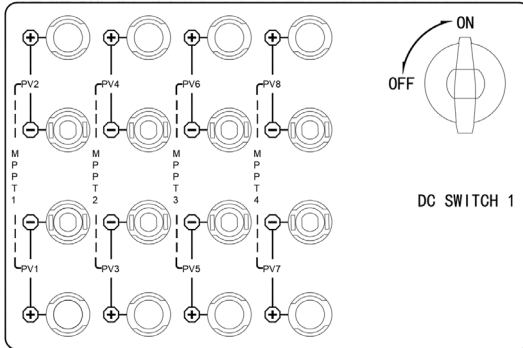

Figure 7-22 DC SWITCH 1 controls the DC terminals PV1 ~ PV8

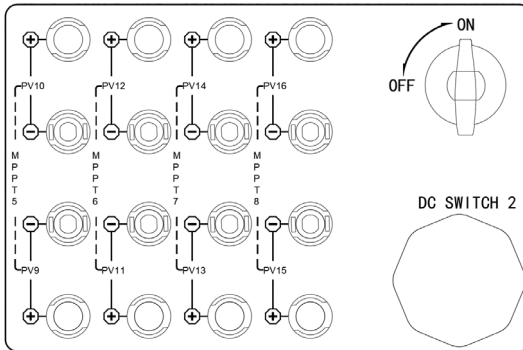

Figure 7-23 DC SWITCH 2 controls the DC terminals PV9 ~ PV16

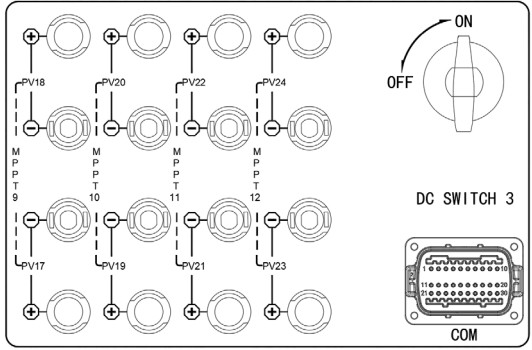

Figure 7-24 DC SWITCH 3 controls the DC terminals PV17 ~ PV24

### PV Terminal Configuration

When the PV strings are not fully connected, the recommended selection for the PV terminals are as follows:

- PV strings should be evenly distributed across the three DC switches controlling the PV terminals.
- Maximize the number of MPPT connections.

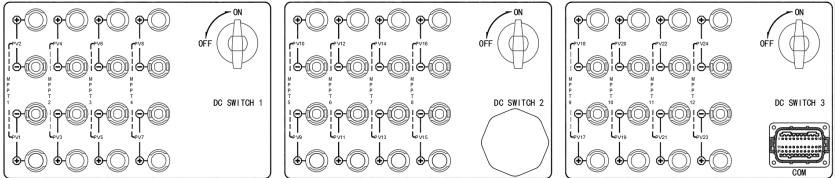

Figure 7-25 Configuration for 1 String Input: Connect to any even terminal.

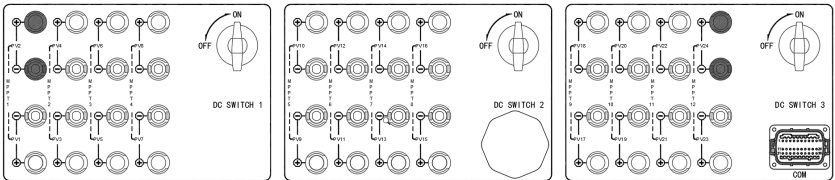

Figure 7-26 Configuration for 2 Strings Input: Connect to PV2, PV24 terminals.

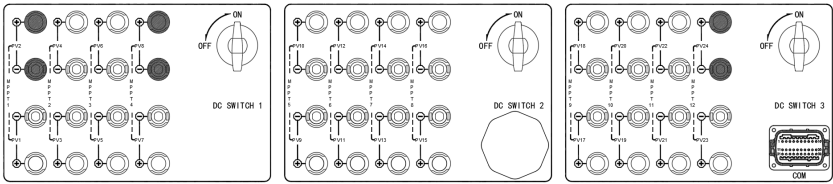

Figure 7-27 Configuration for 3 Strings Input: Connect to PV2, PV8, PV24 terminals.

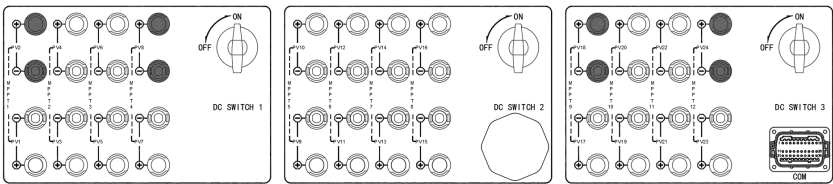

Figure 7-28 Configuration for 4 Strings Input: Connect to PV2, PV8, PV18, PV24 terminals.

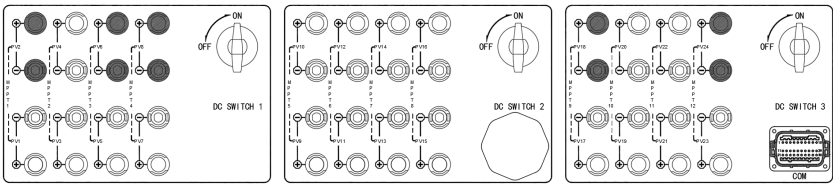

Figure 7-29 Configuration for 5 Strings Input: Connect to PV2, PV6, PV8, PV18, PV24 terminals

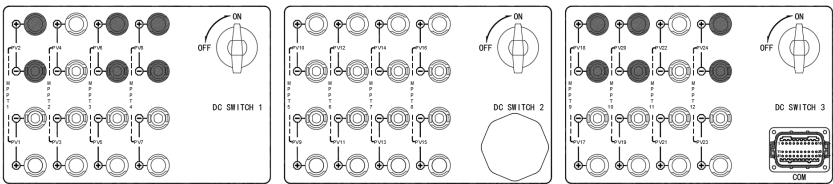

Figure 7-30 Configuration for 6 Strings Input: Connect to PV2, PV6, PV8, PV18, PV20, PV24 terminals.

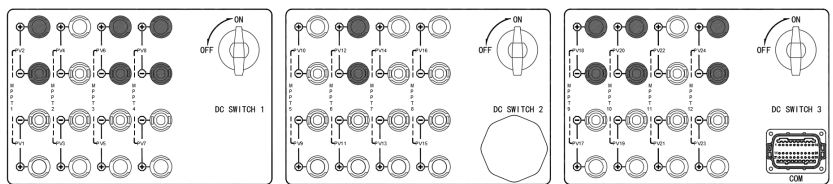

Figure 7-31 Configuration for 7 Strings Input: Connect to PV2, PV6, PV8, PV12, PV18, PV20, PV24 terminals.

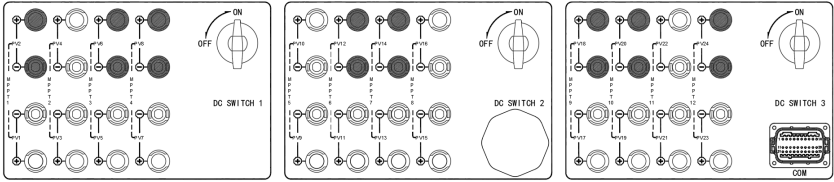

Figure 7-32 Configuration for 8 Strings Input: Connect to PV2, PV6, PV8, PV12, PV14, PV18, PV20, PV24 terminals.

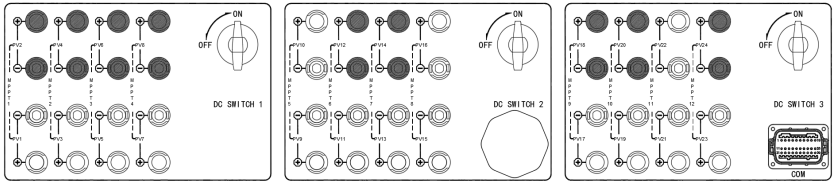

Figure 7-33 Configuration for 9 series inputs: Connect to terminals PV2, PV4, PV6, PV8, PV12, PV14, PV18, PV20, PV24.

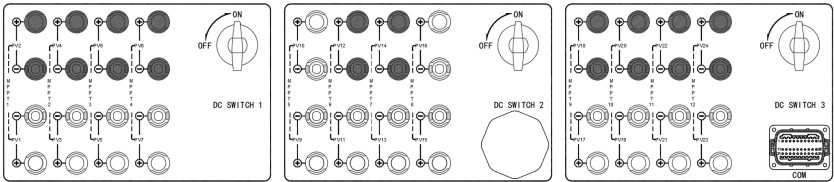

Figure 7-34 Configuration for 10 series inputs: Connect to terminals PV2, PV4, PV6, PV8, PV12, PV14, PV18, PV20, PV22, PV24.

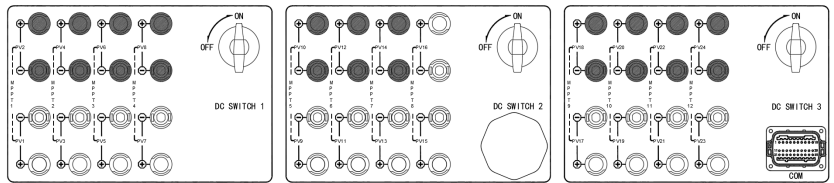

Figure 7-35 Configuration for 11 series inputs: Connect to terminals PV2, PV4, PV6, PV8, PV10, PV12, PV14, PV18, PV20, PV22, PV24.

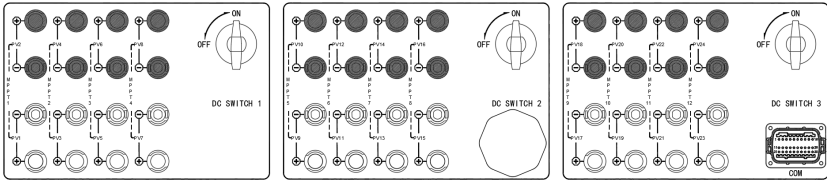

Figure 7-36 Configuration for 12 series inputs: Connect to terminals PV2, PV4, PV6, PV8, PV10, PV12, PV14, PV16, PV18, PV20, PV22, PV24.

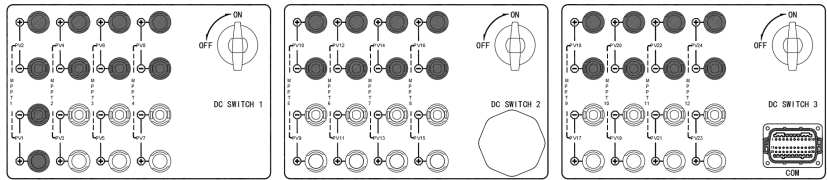

Figure 7-37 Configuration for 13 series inputs: Connect to terminals PV1 ~ PV2, PV4, PV6, PV8, PV10, PV12, PV14, PV16, PV18, PV20, PV22, PV24.

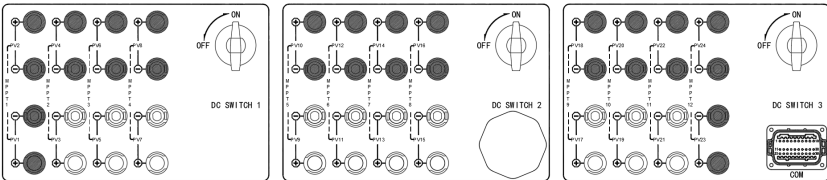

Figure 7-38 Configuration for 14 series inputs: Connect to terminals PV1 ~ PV2, PV4, PV6, PV8, PV10, PV12, PV14, PV16, PV18, PV20, PV22 ~ PV24..

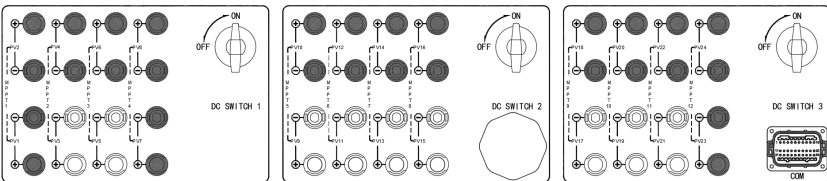

Figure 7-39 Configuration for 15 series inputs: Connect to terminals PV1 ~ PV2, PV4, PV6 ~ PV8, PV10, PV12, PV14, PV16, PV18, PV20, PV22 ~ PV24.

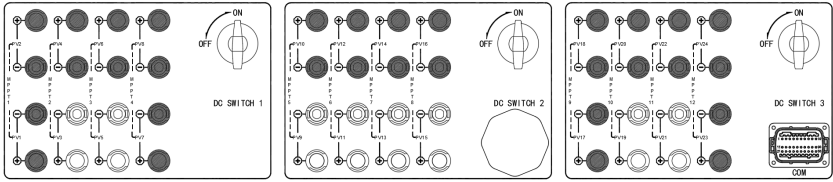

Figure 7-40 Configuration for 16 series inputs: Connect to terminals PV1 ~ PV2, PV4, PV6 ~ PV8, PV10, PV12, PV14, PV16 ~ PV18, PV20, PV22 ~ PV24.

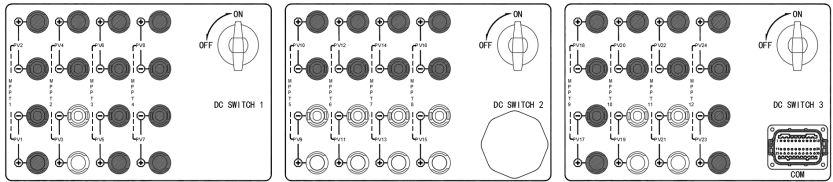

Figure 7-41 Configuration for 17 series inputs: Connect to terminals PV1 ~ PV2, PV4 ~ PV8, PV10, PV12, PV14, PV16 ~ PV18, PV20, PV22 ~ PV24.

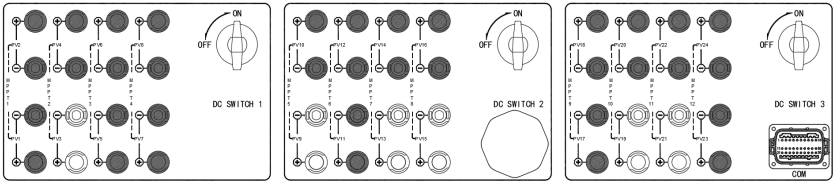

Figure 7-42 Configuration for 18 series inputs: Connect to terminals PV1 ~ PV2, PV4 ~ PV8, PV10 ~ PV12, PV14, PV16 ~ PV18, PV20, PV22 ~ PV24.

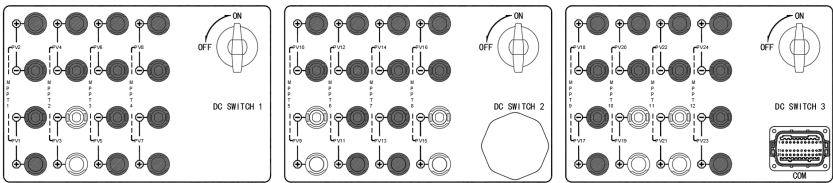

Figure 7-43 Configuration for 19 series inputs: Connect to terminals PV1 ~ PV2, PV4 ~ PV8, PV10 ~ PV14, PV16 ~ PV18, PV20, PV22 ~ PV24.

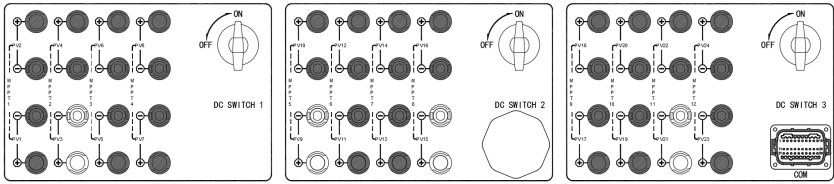

Figure 7-44 Configuration for 20 series inputs: Connect to terminals PV1 ~ PV2, PV4 ~ PV8, PV10 ~ PV14, PV16 ~ PV20, PV22 ~ PV24.

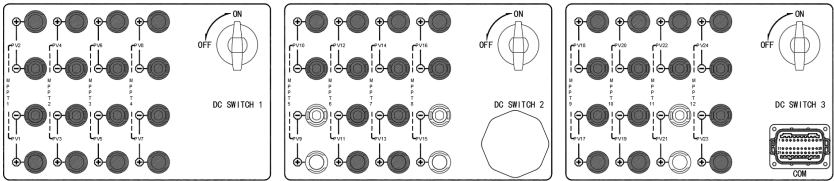

Figure 7-45 Configuration for 21 series inputs: Connect to terminals PV1 ~ PV8, PV10 ~ PV14, PV16 ~ PV20, PV22 ~ PV24..

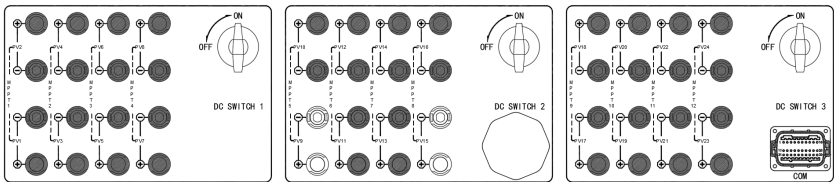

Figure 7-46 Configuration for 22 series inputs: Connect to terminals PV1 ~ PV8, PV10 ~ PV14, PV16 ~ PV24.

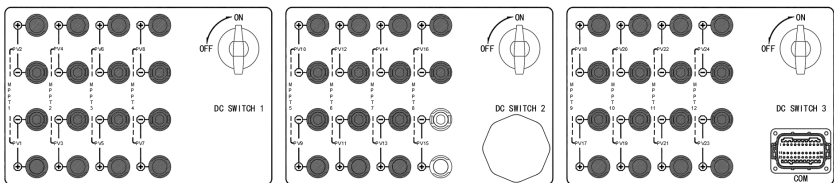

Figure 7-47 Configuration for 23 series inputs: Connect to terminals PV1 ~ PV14, PV16 ~ PV24.

### 7.4.3 PV Wiring Procedure

**Step 1:** Make the PV cable

- a. Find out the positive / negative PV connectors and positive / negative PV pin contacts (part B, C, D, E) from accessory box. Turn off the DC switch and prepare a 4 ~ 6 mm<sup>2</sup> PV cable. Use wire stripper to strip 7 mm insulation layer of the PV cable end.

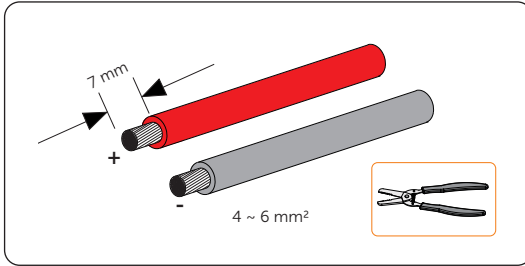

Figure 7-48 Stripping the PV cable

- b. Tighten the stripped section and insert it into the PV pin contact.

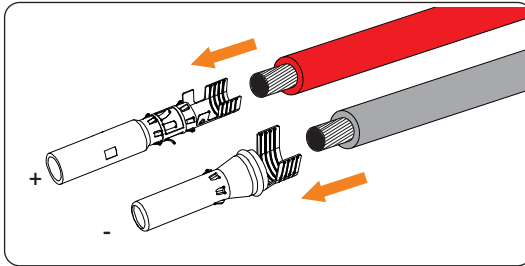

Figure 7-49 Inserting the PV pin contact

- c. Make sure the PV cable and PV pin contact (part E) are of the same polarity. Crimp it with crimping tool for PV terminal. Pay attention to the crimping position.

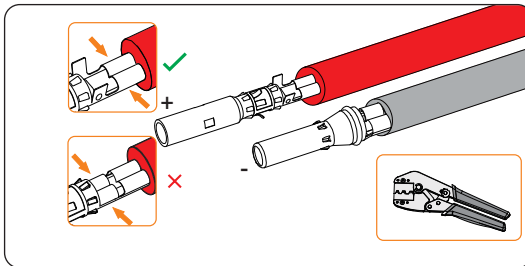

Figure 7-50 Crimping the terminal

- d. Thread the PV cable through swivel nut and insert the cable into the PV connector.

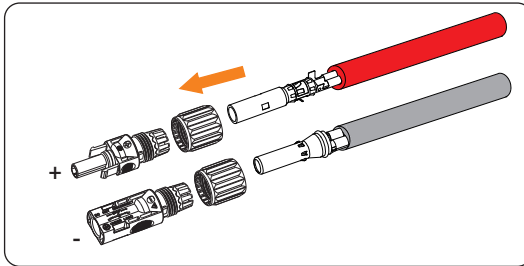

Figure 7-51 Threading the PV cable

- e. A "Click" will be heard if it is connected correctly. Gently pull the cable backward to ensure firm connection. Tighten the swivel nut clockwise. Verify that the PV connectors have the correct polarity before connection.

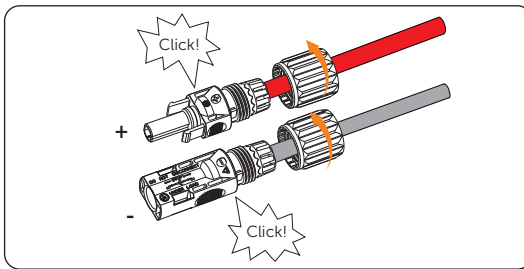

Figure 7-52 Securing the PV cable

**Step 2:** Measure the voltage of DC input

- a. Use a voltage measuring device which complies with the local regulation to measure the positive and negative voltage of the assembled PV connectors and ensure that the voltage of each string is within the range of inverter.

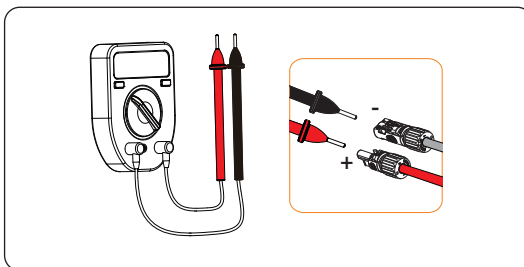

Figure 7-53 Measuring the voltage of PV connectors

**NOTICE!**

- If the voltage reading is negative, it indicates an incorrect DC input polarity. Please check if the wiring connections on the measuring device are correct or PV connectors are not mistakenly connected.

**Step 3:** Connect the PV cable to the inverter. Connect the PV cable to the PV port on the inverter. Seal the unused PV terminals with the dust proof buckles (part F\* & G\*) from the accessory.

**NOTICE!**

- For some counties or regions, the dust proof buckles (part F\* & G\*) are not included in the packing list. Please seal the PV terminals with original caps.

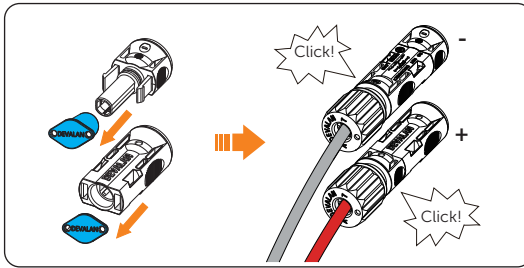

Figure 7-54 Connecting the PV cable

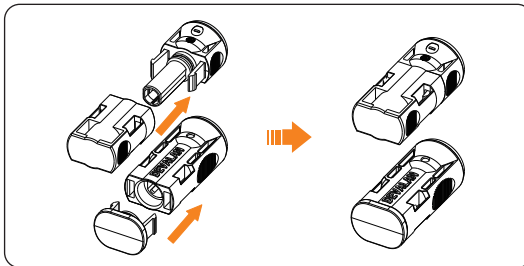

Figure 7-55 Sealing the unused ports

**! DANGER!**

**Electric shock!**

- Do not touch live DC wires. When photovoltaic modules are exposed to light, high voltage will occur, which will lead to the risk of electric shock, resulting in death due to contact with DC conductor.

 **WARNING!**

- Seal the unused PV terminals with the dust proof buckles. If all PV terminals are connected, keep the dust proof buckles in a safe place. Reinstall them immediately after removing the connectors from the terminals.  
(For some counties or regions, the dust proof buckles are not included in the packing list. Please refer to the actual delivery.)

 **WARNING!**

- When the DC cable is reversely connected or the inverter fails to work normally, it is forbidden to turn off the DC switch directly or pull out the DC string.

**NOTICE!**

- Requirements for photovoltaic modules connecting to the same circuit:
  - » All PV modules shall be of the same specification.
  - » All PV modules have the same tilt angle and orientation.
  - » The open circuit voltage of the PV string shall not exceed 1100 V at the coldest expected temperature in time
- The correct operation is as follows:
  - » Use a clamp current meter to measure DC string current.
  - » If it is greater than 0.5 A, please wait until the current is less than 0.5 A.
  - » Only when the current is less than 0.5 A, can the DC power be cut off and the DC string be pulled out.
  - » The inverter damage caused by improper operation will not be included in the warranty.

## 7.5 Communication Connection

### Communication Signal Definition

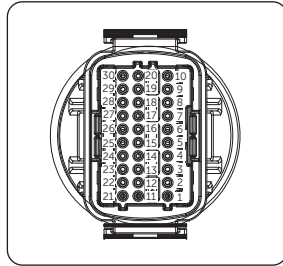

Figure 7-56 Communication port pin number

Table 7-4 Communication port pin definition

Port	Pin	Definition	Remark
RS-485-1	1	RS485A IN+	Inverter RS485 networking or connect the data collector
	2	RS485B IN	
	3	Reserved	
	4	RS485A OUT+	
	5	RS485B OUT	
	6	Reserved	
RS-485-2	7	RS485A METER	Connect the RS485 meter or other devices
	8	RS485B METER	
	9	Reserved	
	10	Reserved	
DRM	11	DRM1/5	Reserved for DRM/RRCR
	12	DRM2/6	
	13	DRM3/7	
	14	DRM4/8	
	15	RG/0	
	16	CL/0	
DI	21	Digital IN+	Input digital signal
	22	Digital IN-	
DO	29	Digital OUT+	Output digital signal
	39	Digital OUT-	

### Connection Steps of Communication Cable

- Step 1:** Select 0.5 ~ 0.75 mm conductor and use wire stripper to strip 12 ~ 14 mm insulation layer of the cable end and insert the insulated cord end terminal to the cable end.  
 ENY0512 nylon terminal for 0.5 mm<sup>2</sup> / 22 AWG conductor;  
 ENY7512 nylon terminal for 0.75 mm<sup>2</sup> / 20 AWG conductor.  
 Use crimping tool to make the terminal in firm contact with the cable end.

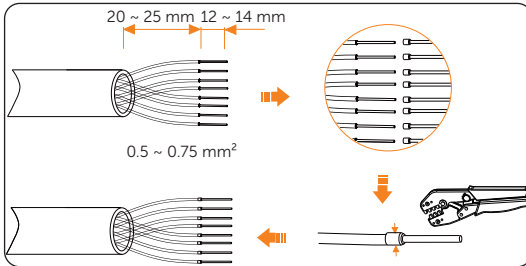

Figure 7-57 Preparing the wire

- Step 2:** Find out the communication connector (part A) from the accessory box and disassemble it into the following parts.

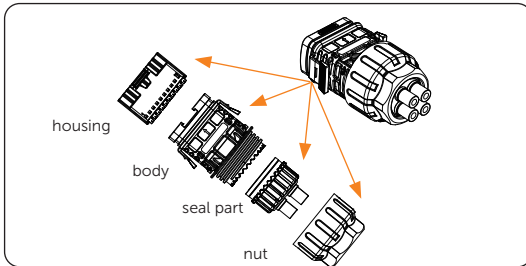

Figure 7-58 Disassembling the connector

- Step 3:** Remove the waterproof plug based on actual needs.

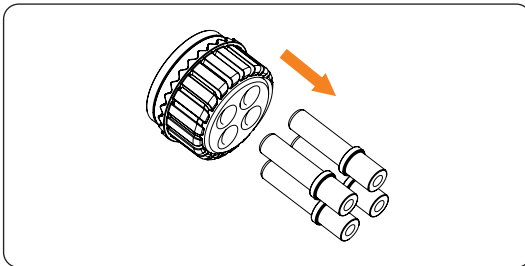

Figure 7-59 Removing the waterproof plug

**Step 4:** Route the COM cable through the component nut, component seal, and component body accordingly.

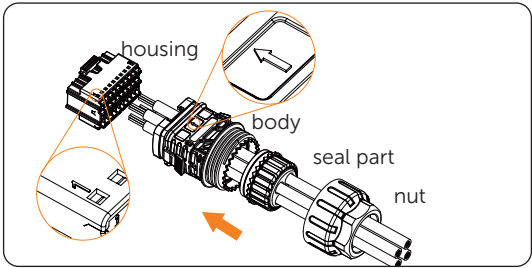

Figure 7-60 Routing the COM cable

**Step 5:** Push the terminal-inserted housing into the body. There will be a slight sound of “Click”, which indicates the connection is completed. Plug the cable into the housing component in accordance with the pin definition in table 7-4.

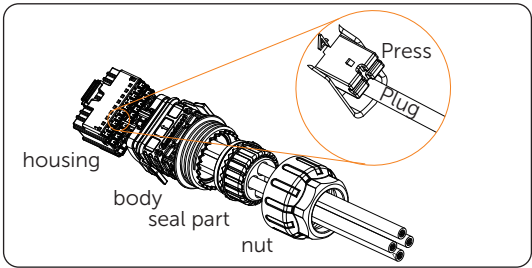

Figure 7-61 Plugging the cable

**Step 6:** Push the seal body into seal part, then push the nut. Clockwise tighten the nut with torque  $8 \pm 2$  N·m.

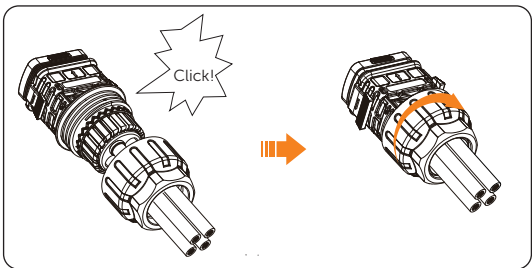

Figure 7-62 Securing the nut

**Step 7:** Keep the buttons on both sides pressed and connect it to the **COM** port of the inverter. There will be a slight sound of “Click” if it is correctly connected.

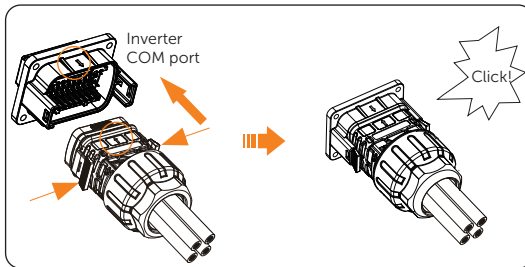

Figure 7-63 Securing and connecting the cable

**\* Disassembling step:** Press the buttons on both sides, pull the plug assembly toward the cable, and disconnect the communication connector from the inverter.

## 7.6 Monitoring Connection

The series of inverters supports the connection of Wi-Fi, LAN, and 4G monitoring modules.

Plug Dongle into **USB** port at the bottom of the inverter. After the DC side and AC side is powered on, the APP and inverter can be connected.

Remember to keep the "QR Code" upwards.

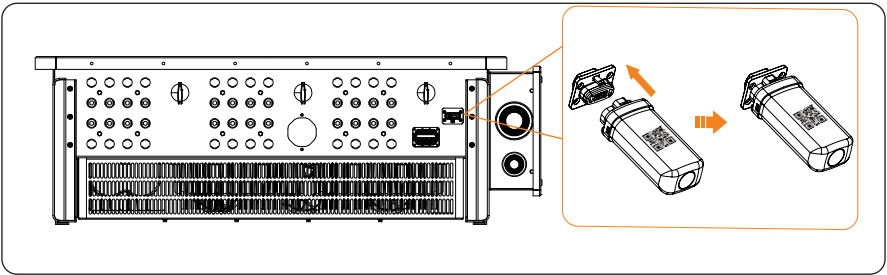

### Monitoring connection diagram

- Wi-Fi connection

Wi-Fi dongle connects to a local network to enable access to the Monitoring Cloud platform.

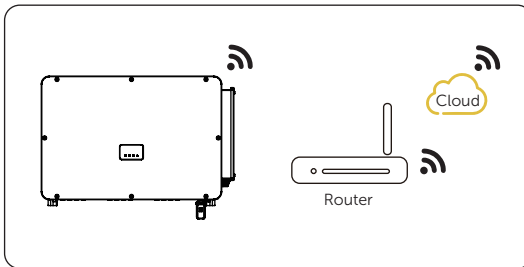

Figure 7-64 Wi-Fi mode connection diagram

- Wi-Fi connection

If Wi-Fi isn't suitable, the LAN dongle enables users to connect to the network via an ethernet cable. Ethernet allows for a much more stable connection with less interference.

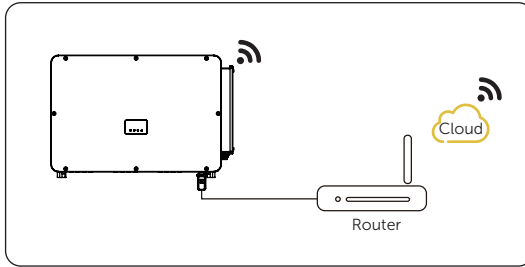

Figure 7-65 LAN mode connection diagram

- 4G connection

4G dongle allows to use a 4G connection to monitor the system without the option of connecting to a local network. (This product is not available in the UK)

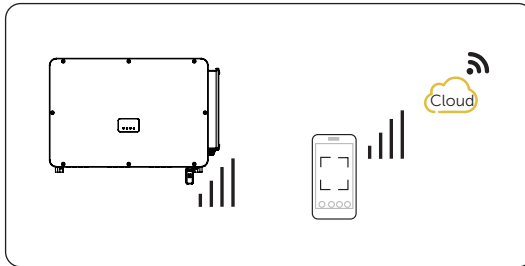

Figure 7-66 4G mode connection diagram

### ⚠ CAUTION!

- The buckles on the inverter and dongle must be on the same side. Otherwise, the dongle may be damaged.

### NOTICE!

- The distance between the router and the inverter must be no more than 100 meters. If there are walls in between, the distance must be no more than 20 meters.
- For locations where Wi-Fi signals are weak, install a Wi-Fi signal booster.

# 8 System Commissioning

---

## 8.1 Checking before Power-on

- The device is installed correctly and securely;
- All the DC breakers and AC breakers are OFF;
- All AC cables are connected correctly and securely;
- All DC cables are connected correctly and securely;
- All communication cables are connected correctly and securely;
- All the connectors which are not used should be sealed by covers.
- Make sure the PV module output is well insulated to ground;
- Make sure all PV modules should be of the same type, same model, same number, aligned and tilted identically;
- Make sure the open circuit voltage of the PV string shall not exceed 800 V (for 40 kW ~ 70 kW inverter) and 1100 V (for 75 kW ~ 150 kW inverter) at the coldest expected temperature in time.

## 8.2 Powering on the System

**Step 1:** Turn on the DC switch at the bottom of the inverter.

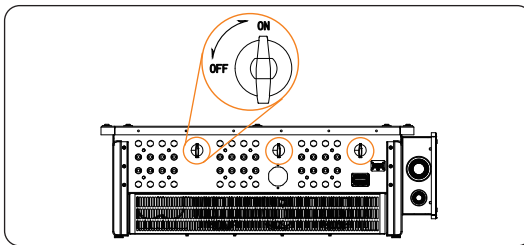

Figure 8-67 Turning on DC switch

**Step 2:** Switch on the AC breaker and wait for the inverter power on. Inverter will start automatically when PV panels generate enough energy. Check the status of LED indicators or LCD panel, the LED indicators should be blue and the LCD panel should display the main interface.

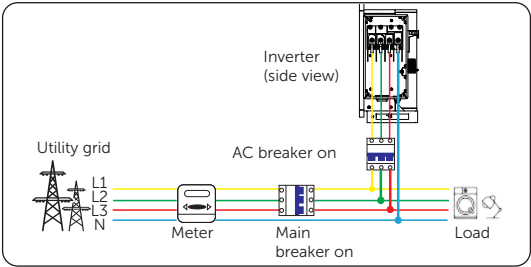

Figure 8-68 Turning on AC breaker

# 9 Operation on LCD

## 9.1 Introduction of Control Panel

### LCD Panel

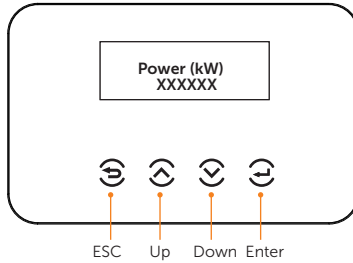

Figure 9-1 Control panel

Table 9-1 Definition of indicators

Key	Definition
ESC key	Exit from the current interface or cancel the setting
Up key	Move the cursor to the previous option or increase the value
Down key	Move the cursor to the next option or decrease the value
Enter key	Enter the selected option or confirm the selection

- In normal state, the **Power**, **TodayEnergy**, **TotalEnergy** and **Status** information will be displayed. You can press the keys to switch information.
- In error state, the fault message and error code will be displayed, please refer to the corresponding solutions in the user manual.

LED indicators

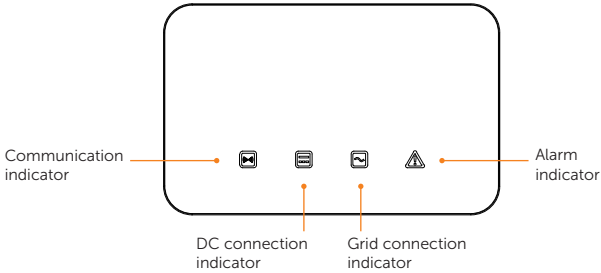





Figure 9-2 Control panel

Table 9-2 Definition of indicators

LED	Status	Definition
Communication indicator (Blue) 	On	The inverter communication is normal.
	Flash	No communication data is sent or received for a long time.
DC connection indicator (Green) 	On	The inverter is in grid-connected state.
	Flash	Alarm indicator on: Errors occur on the inverter DC side. Alarm indicator off: No errors occur on the inverter DC side and at least one channel of MPPT input voltage is higher than 200 V.
	Off	The input voltage of all channels of MPPT is less than 200 V; Or DC switch is not turned on.
Grid connection indicator (Green) 	On	The inverter is in grid-connected state.
	Flash	Alarm indicator on: Errors occur on the inverter AC side. Alarm indicator off: AC grid is connected and the inverter is not in grid-connected state.
	Off	The inverter is not connected to the grid.
Alarm indicator (Red) 	On	Errors occur on the inverter.
	Off	No errors occur on the inverter.

- In aging mode, the alarm indicator light (red) is flashing while the other indicators remain in their current state.
- During software upgrading, all indicators blink in a chasing light pattern.
- If the software upgrade fails, the communication indicator light (blue) goes off, the alarm indicator light (red) remains on, and the DC connection indicator light (green) and grid connection indicator light (green) remain off.
- After a successful inverter upgrade, the communication indicator light (blue) goes off, the alarm indicator light (red), DC side indicator light (green), and grid connection indicator light (green) remain on.

## 9.2 Main interface

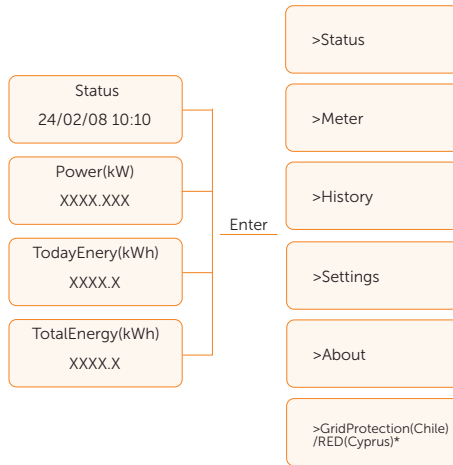

The main interface (Level 1) is the default interface, the inverter will automatically jump to this interface when the system started up successfully or not operated for a period of time.

**Status** shows the time and the current status "Waiting", "Checking", "Running", "Fault" and "Upgrading"; **Power** means the timely output power; **TodayEnergy** means the power generated within the day; **TotalEnergy** means the power generated until now.

Press **Up** and **Down** to review the information.

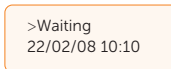

The menu interface (Level 2) is a transfer interface for the user to get into other interface to change the setting or obtain the information. User can get into this interface by pressing **Enter** key when LCD displays the main interface.

User can select **Up** and **Down** key, and press **Enter** to confirm the selection.

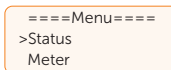

## 9.3 Status

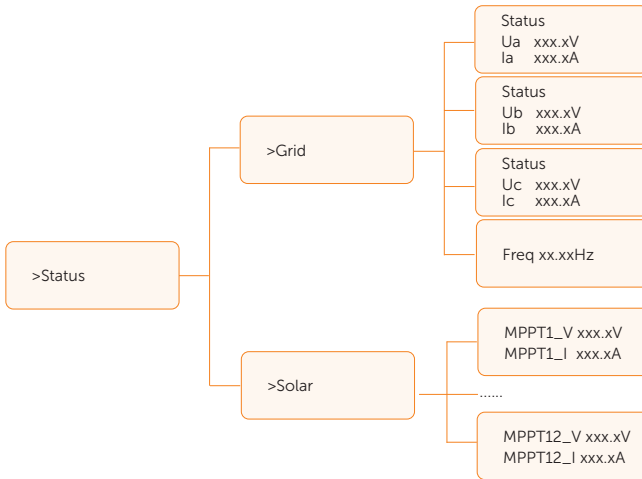

The status function contains **Grid** and **Solar**. Press **Up** and **Down** to select and press **Enter** to confirm the selection. Press **ESC** to return to menu.

```

====Status====
>Grid
Solar
  
```

### 9.3.1 Grid Setting

This status shows the current grid condition such as voltage, and current.

Press **Up** and **Down** button to review the parameter, press **ESC** to return to Status.

```

====Grid====
>Ua xxx.xV
Ia xxxx.xA
  
```

### 9.3.2 Solar Setting

This interface shows the input current and voltage of PV. Totally up to 12 strings of MPPT current and voltage can be checked for the inverter.

```

====Solar====
>MPPT1_V xxx.xV
MPPT1_I xxx.xA
  
```

## 9.4 Meter

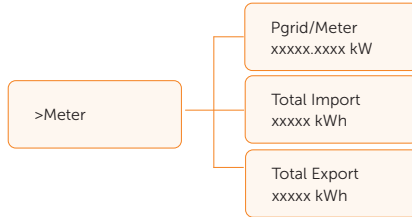

The user can check the active power received from the meter and import/export energy by this function. There are three parameters: **Pgrid/Meter**, **Total Import** and **Total Export**. Press **Up** and **Down** to review the values. If no meter is connected, the parameters here will display 0.

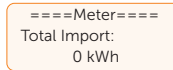

## 9.5 History

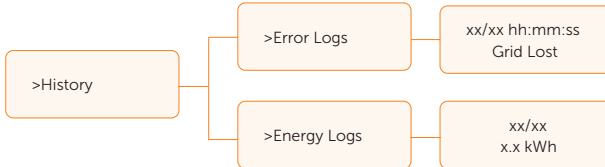

The user can check the error logs and energy logs by this function.

## 9.6 Settings

### NOTICE!

- The setting is displayed under the corresponding safety regulations.

Setting function is used for setting the inverter for safety, system on/off, etc. To set the parameter, please input the password.

Use **0000** as the password for end-users. For installers, Use **2014** as the password to review and modify necessary settings complying to the local rules and regulations. Please change the password promptly for security purposes

If further advanced setting is required, please contact us or the distributor for assistance.

### 9.6.1 Using Users' Password

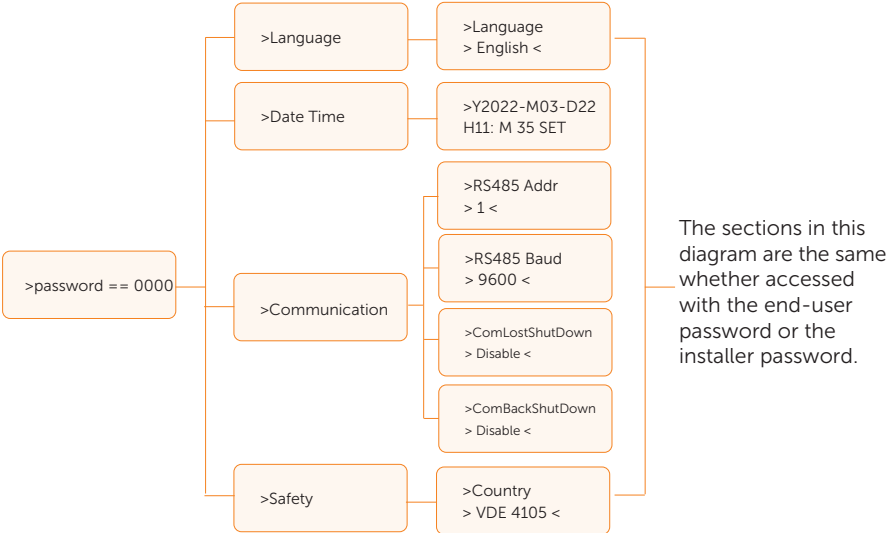

For users, the default password is **0000**, which allows the user to review and modify **Language, Date Time, Communication and Safety.**

```

===Settings===
Password
> 0 0 0 0 SET

```

#### Language

Here user can set the language. At present, English is only available for choosing.

```

===Language===
>Language <
>English<

```

#### Date Time

This interface is for the user to set the system date and time. Increase or decrease the word by pressing **Up** and **Down** key. Press **Enter** to confirm and alternate to next word.

```

===Language===
>Y2022-M03-D22
H11:M35 SET

```

### Communication

RS485 Addr: the modbus address of the external communication protocol.

RS485 Baud: The baud rate of the external communication protocol.

At present, 4800, 9600 and 19200 are supported, and the default is 9600. With this function, the inverter can communicate with the computer, through which the operating status of the inverter can be monitored.

When multiple inverters are monitored by one computer, RS485 communication addresses of different inverters need to be set.

```
==Communication Parameter==  
>RS485 Addr  
1
```

```
==Communication Parameter==  
>RS485 Baud  
9600
```

### Safety

The user can set the safety standard here according to different countries and grid tied standards. There are several standards for choice.

```
===Safety===  
>country  
>VDE 4105<
```

### 9.6.2 Using Installer password

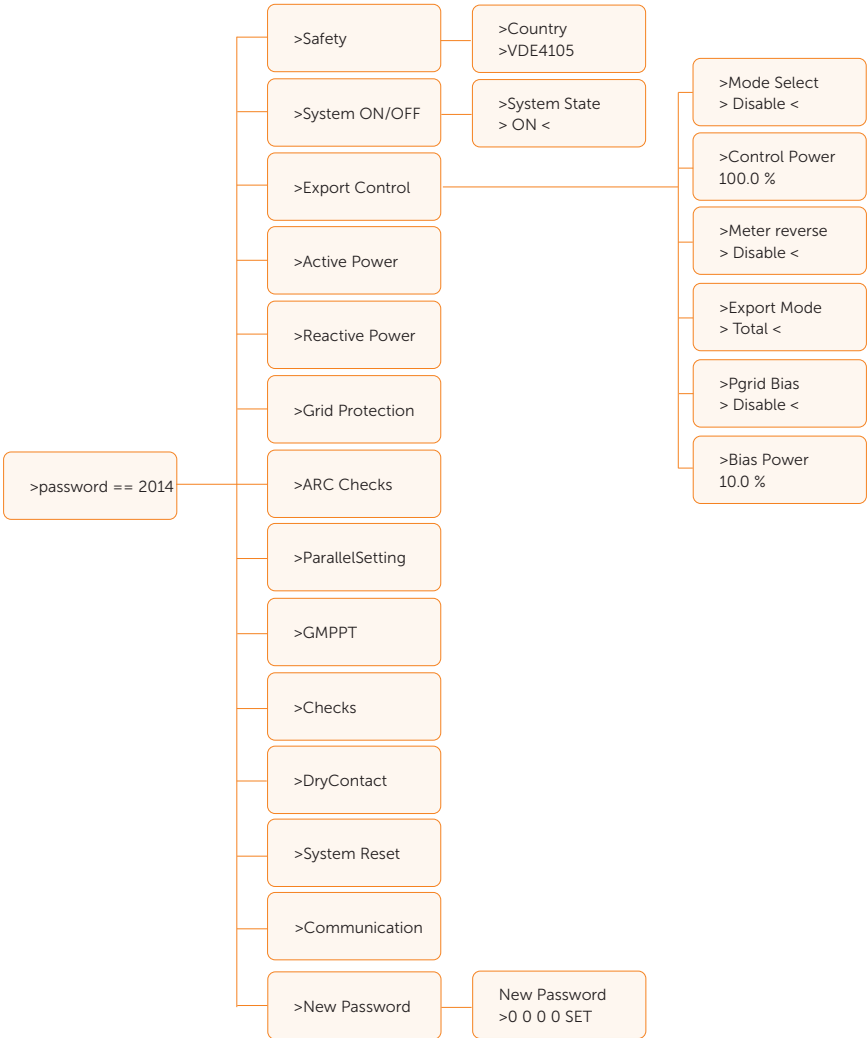

## System ON/OFF

**ON** means the inverter is in working state which is the default state. **OFF** means that the inverter stops running and only the LCD screen is on.

```
===ON/OFF===  
>System state  
>ON<
```

## Export Control

With this power control function, the **Control Power**, **Export Mode**, **Power grid Bias** and **Bias Power** can be set by the installer.

When you set 100% for **Control Power**, it means the energy can be exported to grid with full power. When you set 0%, Exporting to grid is limited. Please set the percentage according to the actual need. Choose **Disable** means the function will not be activated.

Users can set the bias power enable through **PGridBias**. The **ExportMode** parameter allows the selection of the inverter output mode. Setting of **0** transmits the total power of the three phases. Setting of **1** transmits three times the minimum value of the three phases (Per Phase). The default setting is **Total**, which transmits the average value of the three-phase circuit. **Bias Power** represents the feed-in redundancy, with a default value of 0%.

Press **Up** and **Down** button to select and press **Enter** to confirm it.

```
==Export Control==  
>Mode Select  
>Disable<
```

```
==Export Control==  
>Control Power  
100.0%
```

```
==Export Control==  
>Pgrid Bias  
>Disable<
```

```
==Export Control==  
>Export Mode  
>Total<
```

```
==Export Control==  
>Bias Power  
10.0%
```

If the meter is connected reversely, please the enable **Meter reverse** function.

```
==Export Control==  
>Meter reverse  
>Enable<
```

\*Under Australian safety, the user can select **AS4777 Setting** which includes two options: **Export Control**, which relates to active power, and **General Control**, which pertains to reactive power. Both options allow you to configure the **Soft Limit** and **Hard Limit** settings.

**Soft Limit** refers to a setting that limits the grid-connected power to a specified value. If the meter is disconnected, the machine's output power will be restricted to the value set by the soft switch.

**Hard Limit** operates differently. When enabled, it sets a threshold value; if the grid-connected power exceeds this value, the machine will disconnect and report an error.

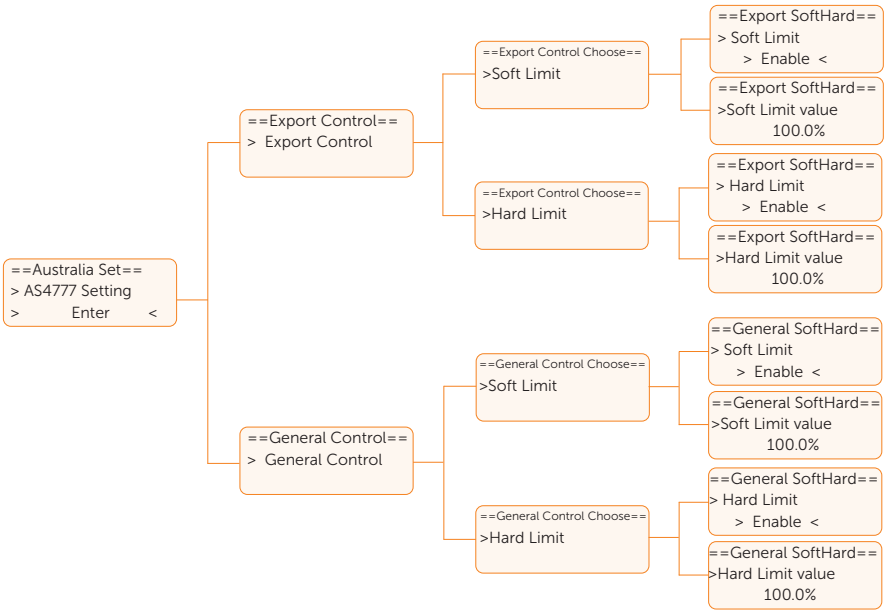

## Active power

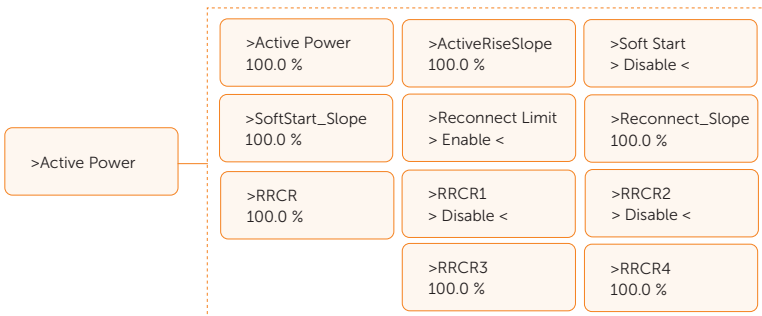

This interface is used to set the active power according to the requirement of utility grid.

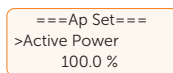

## Reactive power

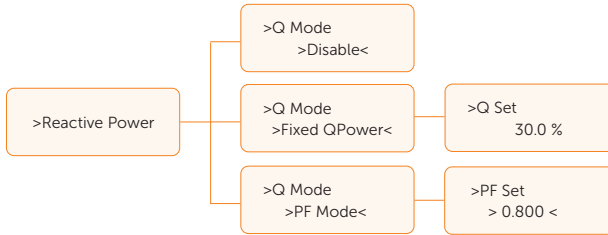

This interface is used to set the reactive power. Please set the value according to the requirement of utility grid.

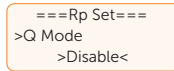

## Grid Protection

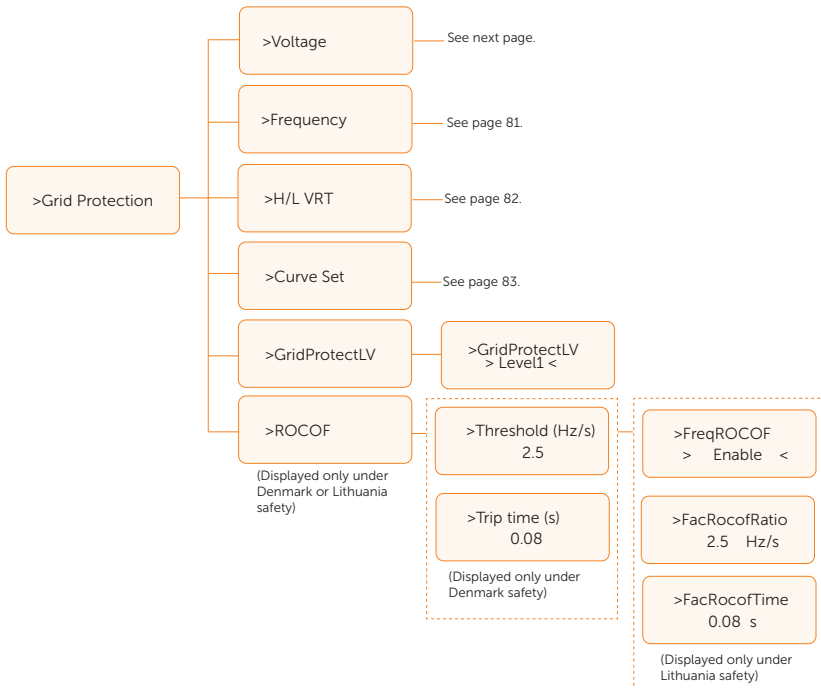

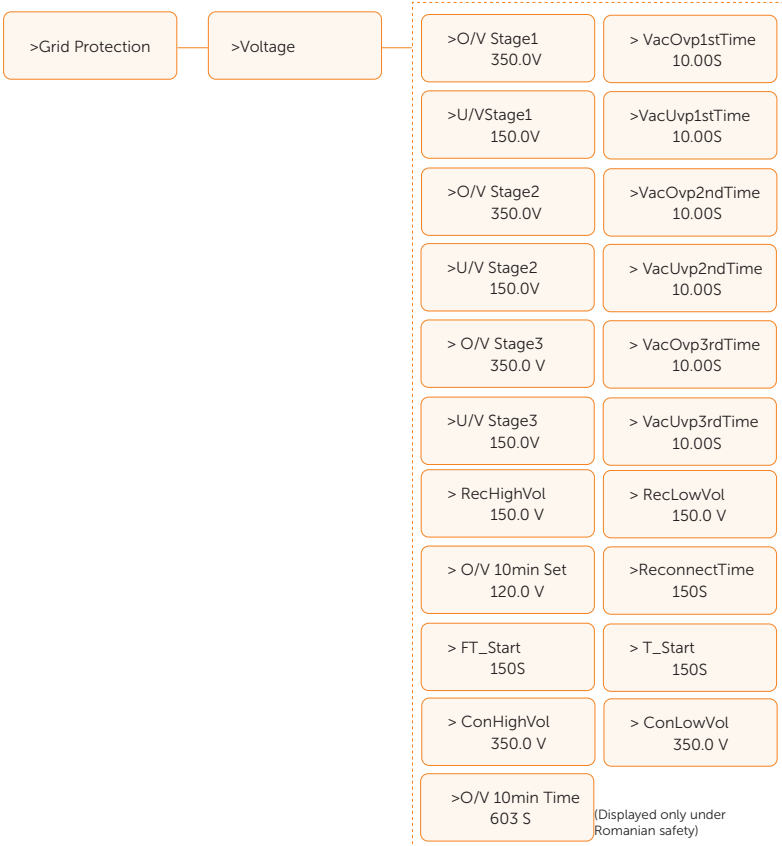

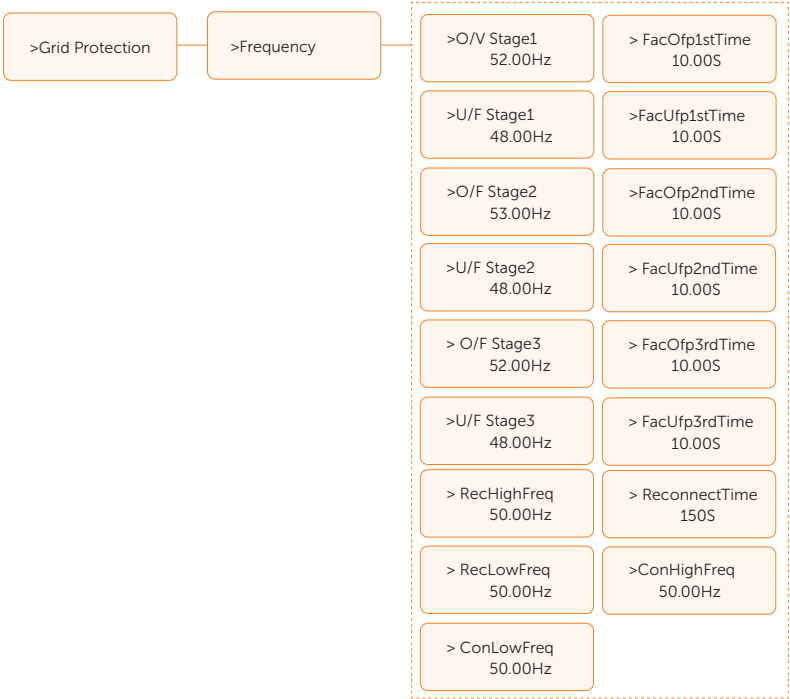

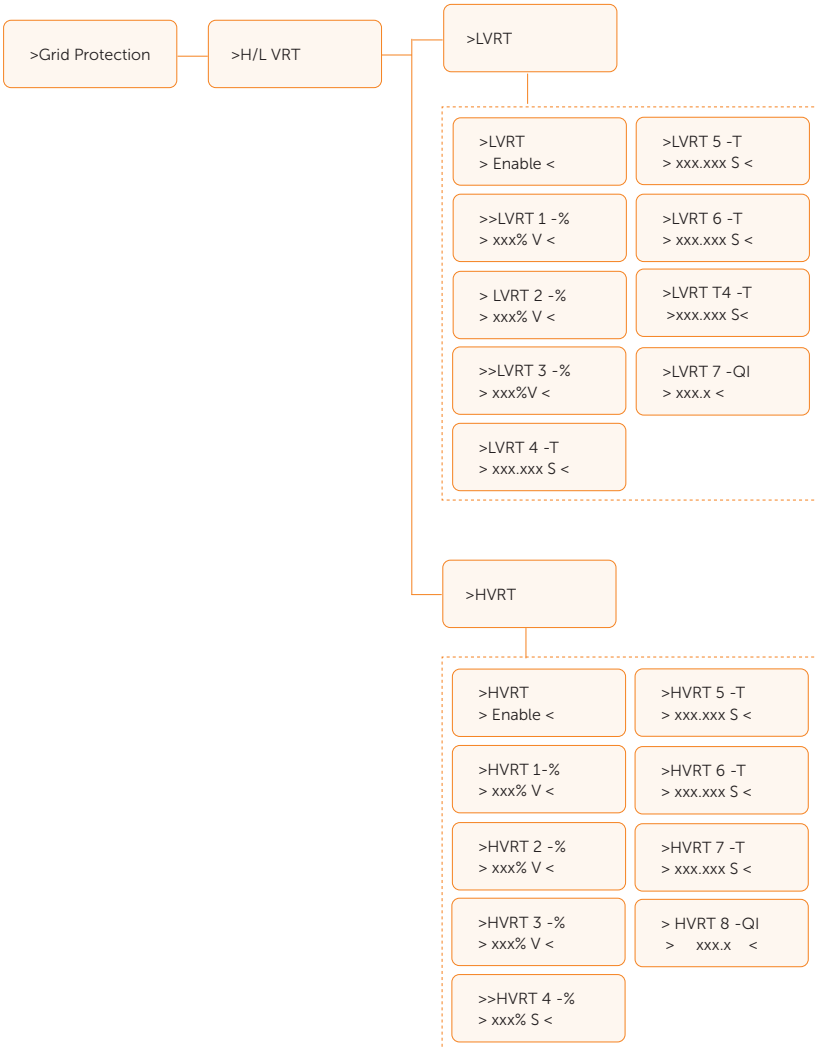

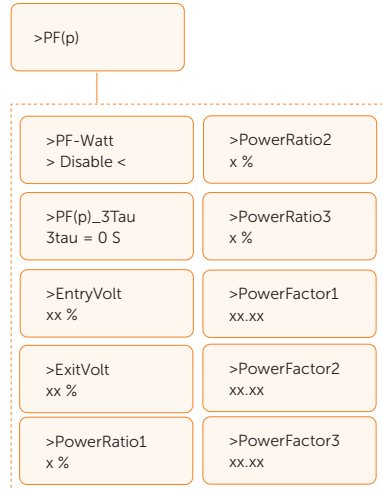
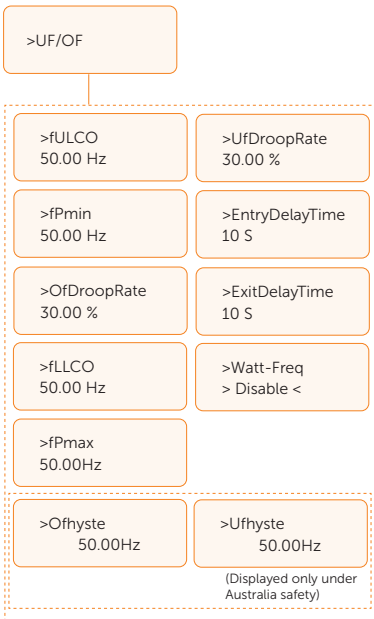
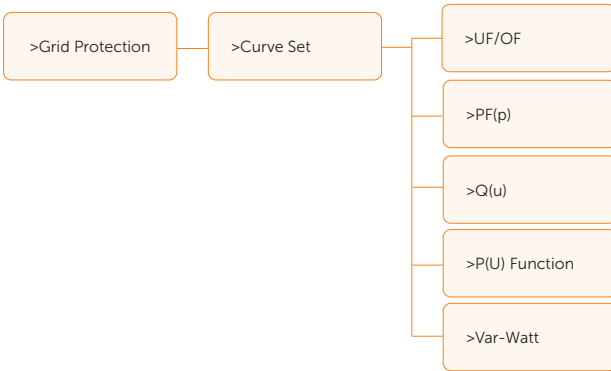

>Q(u)

>Q(u)  
> Disable <

>QuQ1  
0.01 %

>Q(u)\_3Tau  
3tau = 0 S

>QuQ2  
0.01 %

>QuGridV1  
200.0 V

>QuQ3  
0.01 %

>QuGridV2  
200.0 V

>QuQ4  
0.01 %

>QuGridV3  
200.0 V

>QuLockin  
xx %

>QuGridV4  
200.0 V

>QuLockout  
xx %

>P(u) Function

>P(u) Function  
> Disable <

>Pu\_PowerRatio2  
50 %

>PuGridV1  
200.0 V

>Pu\_PowerRatio3  
50 %

>PuGridV2  
200.0 V

>Pu\_PowerRatio4  
50 %

>PuGridV3  
200.0 V

>Pu\_3Tau  
3tau = 0 S

>PuGridV4  
200.0 V

>P(u) Derate  
> Enable <

>Pu\_PowerRatio1  
50 %

>Var-Watt

>Var-Watt  
> Disable <

>Var-Watt 1 - P  
50.0 %

>Var-Watt 2 - P  
50.0 %

>Var-Watt 3 - P  
50.0 %

>Var-Watt 4 - Q  
50.0 %

>Var-Watt 5 - Q  
50.0 %

>Var-Watt6 -Q  
100.0%

>Var-Watt9 -Q  
100.0%

>Var-Watt7 -Q  
100.0%

>Var-Watt10 -Q  
100.0%

>Var-Watt8 -Q  
100.0%

>QP\_3Tau(s)  
6 S

(Displayed only under VDE4110 and VDE4120 safety)

Usually end user do not need to set the grid protection. All default value have been set before leaving factory according to safety rules. If reset is needed, any changes should be made according to the requirements of local grid.

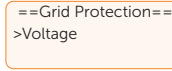

### ARC checks



**ARC Check State** enables arc detection, allowing the system to detect and report any corresponding arc faults that occur during arcing. **ArcSelfCheck** enables a self-check for arc detection functionality, verifying whether the device can correctly identify any detection mechanism faults. **ArcSensitivity** function allows users to adjust the sensitivity of arc fault detection.

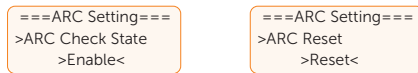

### Parallel Setting

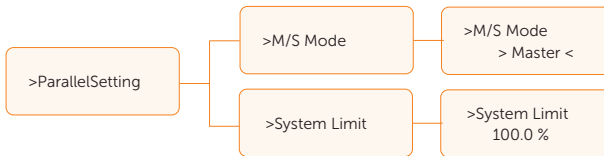

**M/S Mode** can choose **Master** or **Slave**. **System Limit** can set whether to allow the reverse flow power from inverter to power grid, and the default value is 0%. Check [14.2 Application of Parallel Function](#) for detailed settings.

### GMPPT

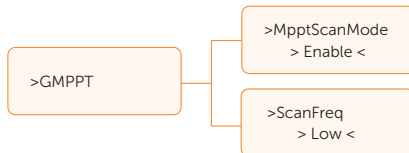

This interface is used to configure GMPPT settings, including MPPT scan mode and scan frequency.

## Checks

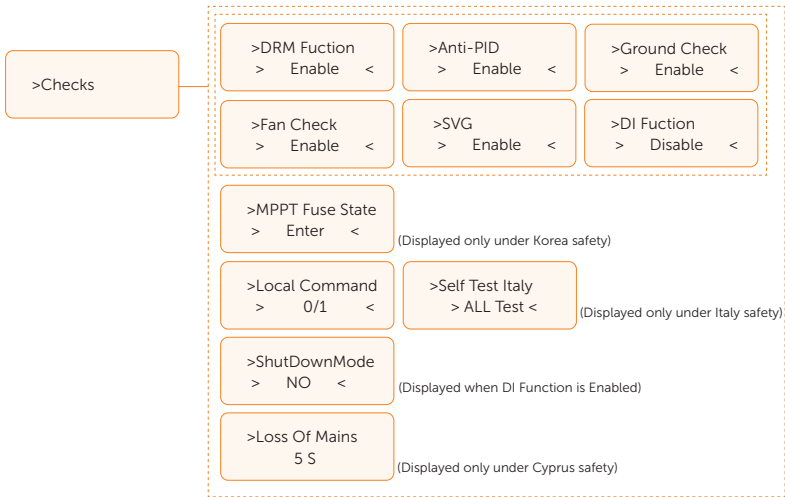

This interface is used to activate the needed functions. Users configure the enable settings for each branch, including Italy self-test, MPPT fuse state, etc.

- **Shut Down** function enables remote control of the inverter switch status by disconnecting or connecting the external switch connected to the inverter.

» **Shut Down/Disable:** Choose **Shut Down** to enable this feature.

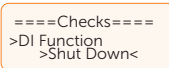

» **NO/NC:** **NO** (Always on) by default.

» **NO** (Always on): When the switch is disconnected, the inverter works normally, and when the switch is connected, the inverter shuts down.

» **NC** (Always closed): When the switch is connected, the inverter works normally, and when the switch is disconnected, the inverter shuts down.

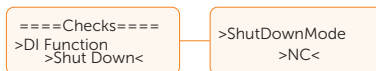

» If the inverter is connected externally to an NS protection device to disconnect the inverter when necessary to protect the system, operate as follows:

» When the inverter is used standalone:

Connect the dry contact to Pin21 and Pin22 of COM port, and enable "**Shut Down** > **ShutDownMode** > **NC**".

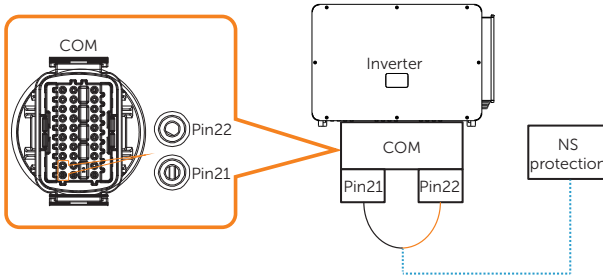

Figure 9-3 Connection diagram for NS Protection

- » When the inverter is running in parallel:  
Connect the inverters in parallel and connect the external NS protection device, with settings the same as those for standalone use.

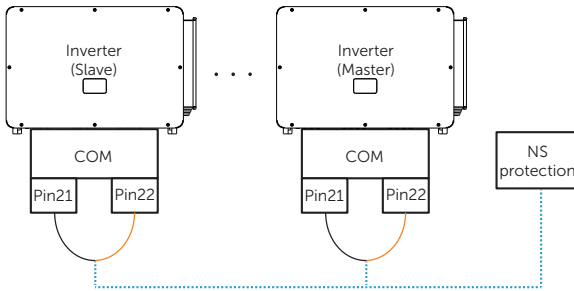
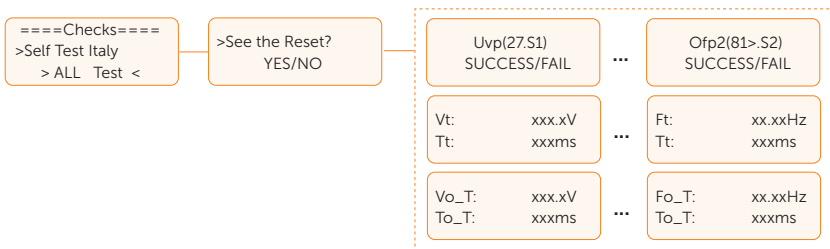

Figure 9-4 Connection diagram for NS Protection in parallel

- Users can enter **MPPT Fuse State** to choose whether to disable the 12 MPPT fuses.



- For **Self Test Italy**, if set to **Disable**, pressing Enter will not bring up the report interface. If set to **All Test**, pressing Enter will confirm and display all report interfaces, with all interfaces linked together. If set to a Single Test, pressing Enter will confirm and display the report for the selected test only.



All test interfaces are as follows:

<p>Uvp(59.S2) SUCCESS/FAIL</p> <p>Vt      xxx.xV Tt      xxx ms</p> <p>Vo_R:    xxx.xV To_R:    xxxms</p> <p>Vo_S:    xxx.xV To_S:    xxxms</p> <p>Vo_T:    xxx.xV To_T:    xxxms</p>	<p>Uvp(27.S1) SUCCESS/FAIL</p> <p>Vt      xxx.xV Tt      xxx ms</p> <p>Vo_R:    xxx.xV To_R:    xxxms</p> <p>Vo_S:    xxx.xV To_S:    xxxms</p> <p>Vo_T:    xxx.xV To_T:    xxxms</p>	<p>Uvp(27.S2) SUCCESS/FAIL</p> <p>Vt      xxx.xV Tt      xxx ms</p> <p>Vo_R:    xxx.xV To_R:    xxxms</p> <p>Vo_S:    xxx.xV To_S:    xxxms</p> <p>Vo_T:    xxx.xV To_T:    xxxms</p>	<p>Ofp(81&gt;.S1) SUCCESS/FAIL</p> <p>Ft:      xx.xxHz Tt:      xxxms</p> <p>Fo_R:    xx.xxHz To_R:    xxxms</p> <p>Fo_S:    xx.xxHz To_S:    xxxms</p> <p>Fo_T:    xx.xxHz To_T:    xxxms</p>
<p>Ufp(81&lt;.S1) SUCCESS/FAIL</p> <p>Ft:      xx.xxHz Tt:      xxxms</p> <p>Fo_R:    xx.xxHz To_R:    xxxms</p> <p>Fo_S:    xx.xxHz To_S:    xxxms</p> <p>Fo_T:    xx.xxHz To_T:    xxxms</p>	<p>Ofp(81&gt;.S2) SUCCESS/FAIL</p> <p>Ft:      xx.xxHz Tt:      xxxms</p> <p>Fo_R:    xx.xxHz To_R:    xxxms</p> <p>Fo_S:    xx.xxHz To_S:    xxxms</p> <p>Fo_T:    xx.xxHz To_T:    xxxms</p>	<p>Ufp(81&lt;.S2) SUCCESS/FAIL</p> <p>Ft:      xx.xxHz Tt:      xxxms</p> <p>Fo_R:    xx.xxHz To_R:    xxxms</p> <p>Fo_S:    xx.xxHz To_S:    xxxms</p> <p>Fo_T:    xx.xxHz To_T:    xxxms</p>	<p>Ovp(27.S2) SUCCESS/FAIL</p> <p>Vt      xxx.xV Tt      xxx ms</p> <p>Vo_R:    xxx.xV To_R:    xxxms</p> <p>Vo_S:    xxx.xV To_S:    xxxms</p> <p>Vo_T:    xxx.xV To_T:    xxxms</p>

## Dry Contact

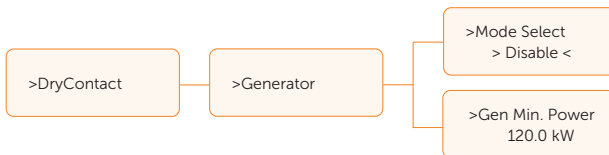

The user can select the operational mode and set the generator's minimum power output. You can also press **Mode Select** to choose to disable the generator.

## System Reset

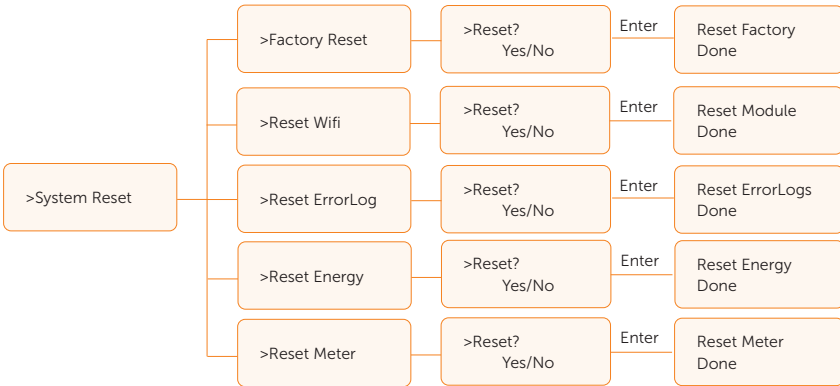

Here you can reset dongle, error logs, energy logs, and meter. In addition, restoring factory default setting is allowed.

Take **Reset Meter** as an example: The user can clear the meter energy by this function. Press **Up** and **Down** button to select and press **Enter** to confirm it. (If you have purchased a SolaX meter, you can reset by selecting the **Start** option.)

## Communication

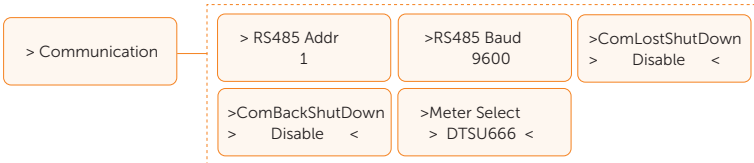

**RS485 Addr** and **RS485 Baud** are the primary communication settings for RS485 which can be configured to 1 and 9600.

**Meter Select** allows users to choose between three connected meters: DTSU666, UMG103CBM, and M3-40.

**Comlostshutdown** and **Combackshutdown** detect meter loss. Meter loss can result from communication disconnection. If **Comlostshutdown** is enabled, the machine will report an error if the meter is lost. If **Combackshutdown** is enabled and the meter is reconnected, the machine will resume operation.

## New Password

Press **Enter** to enter the password setting interface, press **Up** and **Down** when it is flashing, then press **Enter** to confirm the set value. Finally, select **SET** and press **Enter** to confirm the password.

The user can set the new password here. Users need to increase or decrease the word by pressing **Up** or **Down** button. Press **Enter** to confirm and alternate to next word. After word is confirmed, Press **SET** and **Enter** to reset the password.

```

==New Password==
Password
> 0 0 0 0   SET
    
```

## 9.7 About

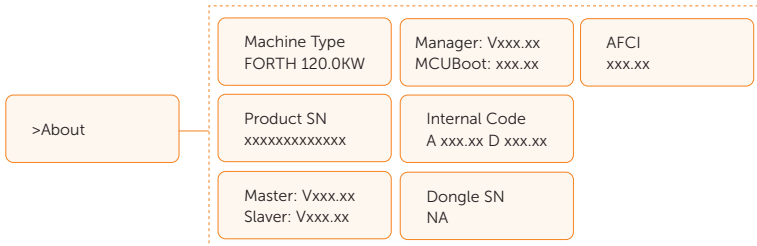

This interface shows information of the inverter, include model, SN, software version of master DSP, slaver and ARM board and internal code.

```

====About====
Product Type
FORTH 120.0KW
    
```

# 10 Operation on SolaX App and Web

---

## 10.1 Introduction of SolaXCloud

SolaXCloud is an intelligent management platform for home energy, which integrates energy efficiency monitoring, device management, data security communication and other integrated capabilities. While managing your home energy device, it helps you optimize the efficiency of electricity consumption and improve the revenue of power generation.

## 10.2 Operation Guide on SolaXCloud App

### 10.2.1 Downloading and Installing App

Method 1: Scan the QR code below to download the app.



Figure 10-1 QR code

QR code can also be available when select **Download APP** on the login page of our official website ([www.solaxcloud.com](http://www.solaxcloud.com)), and the user manual of the dongle.

Method 2: Search for **SolaXCloud** in Apple Store APP or Google Play Store, and then download the app.

### 10.2.2 Operation on the App

For instructions on related operations, create a new account and / or login to see the online tutorial (Click **Service** > **Help Center**) on the SolaXCloud App.

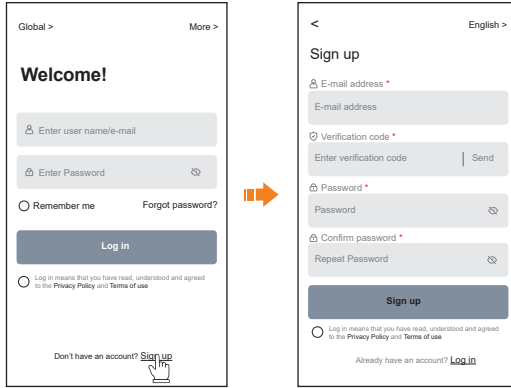

Figure 10-2 Create a new account on SolaXCloud

#### NOTICE!

- The screenshots in this chapter correspond to the SolaXCloud App V6.0.0.

### 10.3 Operations on SolaXCloud Web page

Open a browser and enter [www.solaxcloud.com](http://www.solaxcloud.com) to complete registration, login, add site and other related operations according to the guidelines of User guide.



Table 10-3 User guide on Web

# 11 Troubleshooting and Maintenance

---

## 11.1 Power off

- a. Turn off the system by **System ON/OFF** on LCD screen.
- b. Switch off the DC and AC switch/breaker and disconnect the inverter from DC Input and AC output.
- c. Wait for 5 minutes for de-energizing.



- After the inverter is powered off, there may still be residual electricity and heat which may cause electric shocks and body burns. Please wear personal protective equipment (PPE) and start maintaining the inverter at least five minutes after power off.

## 11.2 Troubleshooting

This section lists the possible problems with the inverter, and provides information and procedures for identifying and resolving them. In case of any errors, check for the warnings or error messages on the system control panel or App, and then refer to the suggestions below. You can check the following list to make sure that the present state of the installation allows proper operation of the unit.

- Is the inverter located in a clean, dry, adequately ventilated place?
- Have the DC input breakers been opened?
- Are the cables adequately sized and short enough?
- Are the input and output connections and wiring in good condition?
- Are the configurations settings correct for your particular installation?
- Are the display panel and the communications cable properly connected and undamaged?

For further assistance, contact SolaX Customer Service. Please provide the model and SN of the inverter, and be prepared to describe the system installation details.

Table 11-1 Troubleshooting list

Error Code	Fault	Diagnosis and Solutions
IE 00	ISO_Fail	PV insulation impedance below safety value 1. Check the PV string impedance to ground, if there is a short circuit or insufficient insulation please rectify the short circuit point; 2. Check whether the protective earth wire of the inverter is correctly connected; 3. If there is no abnormality in the above two points, and the device fault still exists, contact the installer.
IE 01	Meter_Oppsite	Incorrect meter direction 1. Confirm whether the current direction of the meter is correct; 2. Contact the installer.
IE 02	Remote_Off	The inverter receives the shutdown command and is in the shutdown state 1. Send the startup command through app or web to re-run the inverter; 2. Contact the installer.
IE 03	Freq_Cfg_Err	Grid rated frequency setting error 1. According to the local safety regulations, through the APP or monitoring website, reset the parameters; 2. Contact the installer.
IE 04	Gnd_Conn_Err	Inverter grounding fault 1. Check whether the Neutral line of the power grid is correctly connected; 2. Check whether the inverter ground wire is correctly connected; 3. Try to re-run the inverter; 4. Contact the installer
IE 11	PV01_Reverse	Reversed PV connection on MPPT1 (PV01-PV12 respectively represent the PV input channel 1-12) 1. Check whether the positive and negative polarity of the string is reversed, if so, wait until the current of the PV string is reduced to below 0.5A, then put the "DC SWITCH" in the "OFF" position and adjust the polarity of the string; 2. If there is no abnormality in the string check, and the fault still exists, contact the installer.

Error Code	Fault	Diagnosis and Solutions
IE 20	PV_VolHigh	<p>PV input voltage is higher than the allowable value (PV1-PV12 respectively represents 1-12 PV over voltage)</p> <ol style="list-style-type: none"> <li>1. Check the string configuration, reduce the number of PV modules in series, ensure that the open circuit voltage of the string does not exceed the specification requirements, and after the PV array is configured correctly, the inverter alarm will disappear automatically;</li> <li>2. If the string configuration meets the requirements and the fault still exists, contact the installer</li> </ol>
IE 30	BST_SW_OCP	<p>MPPT software over current</p> <ol style="list-style-type: none"> <li>1. The inverter detects the external working conditions in real time, the inverter will resume normal work after the fault disappears, no need for manual intervention;</li> <li>2. If the faults occur frequently and affect the normal power generation of the plant, please check whether the PV input is short-circuited, if it can't be solved, contact the installer.</li> </ol>
IE 40	BST_HW_OCP	<p>MPPT hardware over current</p> <ol style="list-style-type: none"> <li>1. The inverter detects the external working conditions in real time, the inverter will resume normal work after the fault disappears, no need for manual intervention;</li> <li>2. If the faults occur frequently and affect the normal power generation of the plant, please check whether the PV input is short-circuited, if it can't be solved, contact the installer.</li> </ol>
IE 50	Grid_Loss	<p>Power failure of power grid / disconnection of AC line or AC switch.</p> <ol style="list-style-type: none"> <li>1. Check whether the grid voltage is normal;</li> <li>2. Check the power grid electrical connection AC switch;</li> <li>3. Try to restart the inverter.</li> </ol>
IE 51	GridVoL_OP1	<p>The grid voltage exceeds the allowable value</p> <ol style="list-style-type: none"> <li>1. Check whether the voltage at the grid point is too high, if so, please contact the local power operator;</li> <li>2. If it is confirmed that the voltage at the grid point is higher than the permitted range and with the consent of the local power operator, modify the over-voltage protection point through the mobile phone APP or monitoring website;</li> <li>3. Contact the installer.</li> </ol>

Error Code	Fault	Diagnosis and Solutions
IE 53	GridVol_UP1	<p>The grid voltage is lower than the allowable value</p> <ol style="list-style-type: none"> <li>1. If it occurs occasionally, it may be a short time abnormality of the power grid, the inverter will return to normal operation after detecting the power grid is normal, no manual intervention is required;</li> <li>2. If it occurs frequently, please check whether the grid voltage is within the permitted range, if not, please contact the local power operator. If yes, you also need to get the consent of the local power operator and then modify the grid voltage on the mobile phone APP or monitoring website to modify the grid under-voltage protection point;</li> <li>3. Contact the installer.</li> </ol>
IE 55	GridVol_OP_10M	<p>The average grid voltage in 10 minutes exceeds the allowable value</p> <ol style="list-style-type: none"> <li>1. Check whether the grid voltage is within the allowable range;</li> <li>2. Try to re-run the inverter.</li> </ol>
IE 56	GridVol_OP_INST	<p>Instantaneous high voltage of power grid</p> <ol style="list-style-type: none"> <li>1. If it occurs occasionally, it may be a short time abnormality of the power grid, the inverter will return to normal operation after detecting the power grid is normal, no manual intervention is required;</li> <li>2. If it occurs frequently, please check whether the grid frequency is within the permitted range, if not, please contact the local power operator. If yes, you also need to contact the local power operator with the consent of the local power operator to modify the power frequency through the mobile phone APP or monitoring website. If yes, it is also necessary to modify the instantaneous over-voltage protection point of the power grid through the mobile phone APP or monitoring website with the consent of the local power operator;</li> <li>3. Contact the installer.</li> </ol>

Error Code	Fault	Diagnosis and Solutions
IE 57	GridFreq_OP1	<p>Grid frequency exceeds allowable value</p> <ol style="list-style-type: none"> <li>1. If it occurs occasionally, it may be a short time abnormality of the power grid, the inverter will return to normal operation after detecting the power grid is normal, no manual intervention is required;</li> <li>2. If it appears frequently, please check whether the grid frequency is within the permitted range, if not, please contact the local power operator. If yes, you also need to modify the grid over-frequency protection point via mobile phone APP or monitoring website after getting the consent of local power operator;</li> <li>3. Contact the installer.</li> </ol>
IE 5A	GridFreq_UP1	<p>The grid frequency is lower than the allowable value</p> <ol style="list-style-type: none"> <li>1. If it occurs occasionally, it may be a short time abnormality of the power grid, the inverter will return to normal operation after detecting the power grid is normal, no manual intervention is required;</li> <li>2. If it appears frequently, please check whether the grid frequency is within the permitted range, if not, please contact the local power operator. If yes, you also need to modify the grid over-frequency protection point via mobile phone APP or monitoring website after getting the consent of local power operator;</li> <li>3. Contact the installer.</li> </ol>
IE 5B	GridPhase_Loss	<p>Loss of grid phase voltage</p> <ol style="list-style-type: none"> <li>1. Check the grid voltage;</li> <li>2. Check the power grid electrical connection AC switch;</li> <li>3. Try to re-run the inverter.</li> </ol>
IE 5C	Grid_Unbalance	<p>Grid voltage imbalance</p> <ol style="list-style-type: none"> <li>1. Check whether the grid voltage is within the allowable range;</li> <li>2. Try to re-run the inverter.</li> </ol>
IE 5D	Grid_FRT	<p>Grid fault</p> <ol style="list-style-type: none"> <li>1. Check whether the grid voltage is within the allowable range;</li> <li>2. Try to re-run the inverter;</li> </ol>
IE 60	DCBus_HW_OVP	<p>Bus hardware over voltage</p> <ol style="list-style-type: none"> <li>1. The inverter monitors the external working conditions in real time, and the inverter will resume normal operation after the fault disappears, without manual intervention;</li> <li>2. If faults occur frequently, please contact the installer.</li> </ol>

Error Code	Fault	Diagnosis and Solutions
IE 61	PBus_FSW_OVP	<p>Bus software over-voltage</p> <p>1. The inverter monitors the external working conditions in real time, and the inverter will resume normal operation after the fault disappears, without manual intervention;</p> <p>2. If faults occur frequently, please contact the installer.</p>
IE 62	NBus_FSW_OVP	<p>Bus software over voltage</p> <p>1. The inverter monitors the external working conditions in real time, and the inverter will resume normal operation after the fault disappears, without manual intervention;</p> <p>2. If faults occur frequently, please contact the installer.</p>
IE 63	DCBus_SW_OVP	<p>Bus software over voltage</p> <p>1. The inverter monitors the external working conditions in real time, and the inverter will resume normal operation after the fault disappears, without manual intervention;</p> <p>2. If faults occur frequently, please contact the installer.</p>
IE 64	DCBus_SW_UVP	<p>Bus software under voltage</p> <p>1. The inverter monitors the external working conditions in real time, and the inverter will resume normal operation after the fault disappears, without manual intervention;</p> <p>2. If faults occur frequently, please contact the installer.</p>
IE 65	DCBus_Unbalance	<p>Bus imbalance</p> <p>1. The inverter monitors the external working conditions in real time, and the inverter will resume normal operation after the fault disappears, without manual intervention;</p> <p>2. If faults occur frequently, please contact the installer.</p>
IE 66	PV_Above_Bus	<p>The PV voltage is higher than the Bus voltage</p> <p>1. The inverter monitors the external working conditions in real time, and the inverter will resume normal operation after the fault disappears, without manual intervention;</p> <p>2. If faults occur frequently, please contact the installer.</p>
IE 67	DcBus_SSErr	<p>Bus soft start failure</p> <p>1. The inverter monitors the external working conditions in real time, and the inverter will resume normal operation after the fault disappears, without manual intervention;</p> <p>2. If faults occur frequently, please contact the installer.</p>

Error Code	Fault	Diagnosis and Solutions
IE 68	SunPWR_Weak	<p>Low PV power</p> <p>1. The inverter monitors the external working conditions in real time, and the inverter will resume normal operation after the fault disappears, without manual intervention;</p> <p>2. If faults occur frequently, please contact the installer.</p>
IE 70	InvRelay_Err	<p>Relay fault</p> <p>1. The inverter monitors the external working conditions in real time, and the inverter will resume normal operation after the fault disappears, without manual intervention;</p> <p>2. If faults occur frequently, please contact the installer.</p>
IE 71	Relay_OnErr	<p>Relay pull in fault</p> <p>1. The inverter monitors the external working conditions in real time, and the inverter will resume normal operation after the fault disappears, without manual intervention;</p> <p>2. If faults occur frequently, please contact the installer.</p>
IE 72	Inv_SW_OCP	<p>Inverter software over current</p> <p>1. The inverter monitors the external working conditions in real time, and the inverter will resume normal operation after the fault disappears, without manual intervention;</p> <p>2. If faults occur frequently, please contact the installer.</p>
IE 73	Inv_PkCur_OL	<p>Inverter peak over current fault</p> <p>1. The inverter monitors the external working conditions in real time, and the inverter will resume normal operation after the fault disappears, without manual intervention;</p> <p>2. If faults occur frequently, please contact the installer.</p>
IE 74	Inv_HW_OCP	<p>Inverter hardware over current</p> <p>1. The inverter monitors the external working conditions in real time, and the inverter will resume normal operation after the fault disappears, without manual intervention;</p> <p>2. If faults occur frequently, please contact the installer.</p>
IE 75	Inv_DCI_Err	<p>DCI exceeds allowable value</p> <p>1. The inverter monitors the external working conditions in real time, and the inverter will resume normal operation after the fault disappears, without manual intervention;</p> <p>2. If faults occur frequently, please contact the installer.</p>

Error Code	Fault	Diagnosis and Solutions
IE 76	Inv_SC_Err	<p>Inverter peak over current fault</p> <ol style="list-style-type: none"> <li>1. The inverter monitors the external working conditions in real time, and the inverter will resume normal operation after the fault disappears, without manual intervention;</li> <li>2. If faults occur frequently, please contact the installer.</li> </ol>
IE 77	GFCI_CT_Err	<p>GFCI sensor failure</p> <ol style="list-style-type: none"> <li>1. The inverter monitors the external working conditions in real time, and the inverter will resume normal operation after the fault disappears, without manual intervention;</li> <li>2. If faults occur frequently, please contact the installer.</li> </ol>
IE 78	GFCI_Err	<p>GFCI failure</p> <ol style="list-style-type: none"> <li>1. The inverter monitors the external working conditions in real time, and the inverter will resume normal operation after the fault disappears, without manual intervention;</li> <li>2. If faults occur frequently, please contact the installer.</li> </ol>
IE 7B	Inv_HW_OCPA	<p>Inverter hardware over current fault</p> <ol style="list-style-type: none"> <li>1. The inverter monitors the external working conditions in real time, and the inverter will resume normal operation after the fault disappears, without manual intervention;</li> <li>2. If faults occur frequently, please contact the installer.</li> </ol>
IE 80	Bst_IGBT_NTC_OTP	<p>Boost module temperature above allowable value</p> <ol style="list-style-type: none"> <li>1. Check if the inverter installation location is well ventilated and the ambient temperature is not beyond the maximum permissible ambient temperature range, if the ventilation is not good or the ambient temperature is too high, please improve the ventilation and heat dissipation condition;</li> <li>2. If the ventilation is good and the ambient temperature is normal, but the inverter fault still exists, please contact the installer.</li> </ol>
IE 81	Inv_IGBT_NTC_OTP	<p>The temperature of inverter module is higher than the allowable value</p> <ol style="list-style-type: none"> <li>1. Check if the inverter installation location is well ventilated and the ambient temperature is not beyond the maximum permissible ambient temperature range, if the ventilation is not good or the ambient temperature is too high, please improve the ventilation and heat dissipation condition;</li> <li>2. If the ventilation is good and the ambient temperature is normal, but the inverter fault still exists, please contact the installer.</li> </ol>

Error Code	Fault	Diagnosis and Solutions
IE 82	AC_TB_NTC_OTP	<p>The AC terminal temperature is higher than the allowable value</p> <ol style="list-style-type: none"> <li>1. Check if the inverter installation location is well ventilated and the ambient temperature is not beyond the maximum permissible ambient temperature range, if the ventilation is not good or the ambient temperature is too high, please improve the ventilation and heat dissipation condition;</li> <li>2. If the ventilation is good and the ambient temperature is normal, but the inverter fault still exists, please contact the installer.</li> </ol>
IE 83	Envir_Tmp_High	<p>The internal temperature is higher than the allowable value</p> <ol style="list-style-type: none"> <li>1. Check if the inverter installation location is well ventilated and the ambient temperature is not beyond the maximum permissible ambient temperature range, if the ventilation is not good or the ambient temperature is too high, please improve the ventilation and heat dissipation condition;</li> <li>2. If the ventilation is good and the ambient temperature is normal, but the inverter fault still exists, please contact the installer.</li> </ol>
IE 84	Envir_Tmp_Low	<p>The internal temperature is lower than the allowable value</p> <ol style="list-style-type: none"> <li>1. Check if the inverter installation location is well ventilated and the ambient temperature is not beyond the maximum permissible ambient temperature range, if the ventilation is not good or the ambient temperature is too high, please improve the ventilation and heat dissipation condition;</li> <li>2. If the ventilation is good and the ambient temperature is normal, but the inverter fault still exists, please contact the installer.</li> </ol>
IE 85	TmpSensor_Loss	<p>Temperature sensor connection failure</p> <ol style="list-style-type: none"> <li>1. Contact the installer to reconfigure the device.</li> </ol>
IE 91	Comm_SPI_Err	<p>Internal SPI failure</p> <ol style="list-style-type: none"> <li>1. If the abnormality is introduced by an external fault, the inverter automatically resumes normal operation after the fault disappears without manual intervention;</li> <li>2. If this alarm occurs frequently, please contact the installer.</li> </ol>

Error Code	Fault	Diagnosis and Solutions
IE 92	Comm_CAN_Err	<p>Internal CAN failure</p> <ol style="list-style-type: none"> <li>1. If the abnormality is introduced by an external fault, the inverter automatically resumes normal operation after the fault disappears without manual intervention;</li> <li>2. If this alarm occurs frequently, please contact the installer.</li> </ol>
IE 93	EPRM_RW_Err	<p>EEPROM fault</p> <ol style="list-style-type: none"> <li>1. If the abnormality is introduced by an external fault, the inverter automatically resumes normal operation after the fault disappears without manual intervention;</li> <li>2. If this alarm occurs frequently, please contact the installer.</li> </ol>
IE 94	FAN1_Err	<p>Fan 1 fault</p> <ol style="list-style-type: none"> <li>1. If the abnormality is introduced by an external fault, the inverter automatically resumes normal operation after the fault disappears without manual intervention;</li> <li>2. If this alarm occurs frequently, please contact the installer.</li> </ol>
IE 95	FAN2_Err	<p>Fan 2 fault</p> <ol style="list-style-type: none"> <li>1. If the abnormality is introduced by an external fault, the inverter automatically resumes normal operation after the fault disappears without manual intervention;</li> <li>2. If this alarm occurs frequently, please contact the installer.</li> </ol>
IE 96	MOV_AC_Err	<p>AC lightning protection module failure</p> <ol style="list-style-type: none"> <li>1. If the abnormality is introduced by an external fault, the inverter automatically resumes normal operation after the fault disappears without manual intervention;</li> <li>2. If this alarm occurs frequently, please contact the installer.</li> </ol>
IE 97	MOV_DC_Err	<p>DC lightning protection module failure</p> <ol style="list-style-type: none"> <li>1. If the abnormality is introduced by an external fault, the inverter automatically resumes normal operation after the fault disappears without manual intervention;</li> <li>2. If this alarm occurs frequently, please contact the installer.</li> </ol>
IE A0	Type_Model_Err	<p>Model setting error</p> <p>Contact the installer to reconfigure the device.</p>
IE A1	SW_VerMisMatch	<p>Software version unmatched error</p> <ol style="list-style-type: none"> <li>1. Contact the installer to reconfigure the device.</li> </ol>
/	Screen not on	<p>Check if the inverter correctly and normally connected.</p> <p>Contact SolaX for help if the inverter is connected correctly.</p>

Error Code	Fault	Diagnosis and Solutions
/	Screen on but no content display	Contact SolaX for help.

### 11.3 Maintenance

Regular maintenance is required for the inverter. Please check and maintain the following items based on the instructions below to ensure the optimal performance of the inverter. For inverters working in inferior conditions, more frequent maintenance is required. Please keep maintenance records.

 **WARNING!**

- Only qualified person can perform the maintenance for the inverter.
- Only spare parts and accessories authorized by SolaX can be used for maintenance.

#### Proposal of Maintenance

Table 11-2 Proposal of Maintenance

Item	Check notes	Maintenance interval
Fans	<ul style="list-style-type: none"> <li>Check if the fan makes noise or is covered by dust.</li> <li>Clean the fan with a soft and dry cloth or brush, or replace the fan if necessary.</li> </ul>	Every 12 months
Electrical connection	<ul style="list-style-type: none"> <li>Ensure that all cables are firmly connected.</li> <li>Check the integrity of the cables, ensuring that there are no scratches on the parts touching the metallic surface.</li> <li>Verify that the unused PV sealing caps on idle terminals are not falling off.</li> <li>Check that if the input and output wires are damaged or aged.</li> </ul>	Every 12 months
Grounding reliability	<ul style="list-style-type: none"> <li>Check if the grounding cables are firmly connected to the grounding terminals as well as all terminals and ports are properly sealed. Use a ground resistance tester to test the grounding resistance from the inverter enclosure to the PE bar in the power distribution box.</li> </ul>	Every 6 months
Heat sink	<ul style="list-style-type: none"> <li>Check if there are foreign objects in the heat sink.</li> </ul>	Every 12 months

Item	Check notes	Maintenance interval
General status of inverter	<ul style="list-style-type: none"> <li>• Check if there is any damage on the inverter.</li> <li>• Check if there is any abnormal sound when the inverter is running.</li> </ul>	Every 6 months
Cooling fans	<ul style="list-style-type: none"> <li>• Check that if the cooling fans on the rear of inverter are covered by dirt, and the device should be cleaned and absorbed dust when necessary.</li> </ul>	Every time as-needed
Indicators	<ul style="list-style-type: none"> <li>• Check that if the indicators of the inverter are in normal state, check if the display of the inverter (if it has screen) is normal.</li> <li>• Get the inverter panels cleaned and their safety checked.</li> </ul>	Every 6 months

### Fan Maintenance Schedule

The external fan of inverter is in operation for a long time. In order to keep the fan in normal working state, it is necessary to clean the fan regularly.

If the service life is too long, the fan may fail, and the fan needs to be repaired or replaced. The maintenance or replacement requires professional operation.

**Step 1:** Before maintenance of fan, the AC connection must be disconnected, then the DC switch must be disconnected and wait 5 minutes till the inverter is completely OFF.

**Step 2:** Remove the fan support fixing screw as shown in the figure below. Pull out the fan bracket, stop at the position about 150 mm, then pull off the fan waterproof connector, then pull the fan bracket again to pull out the whole bracket.

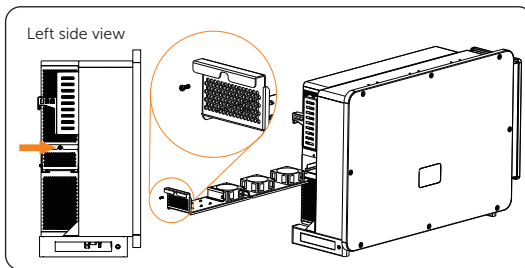

Figure 11-1 Removing the screw and pulling out the bracket

**Step 3:** Clean and repair the fan.

**Step 4:** Restore the installation of fan bracket and tighten the fixing screws.

## 11.4 Upgrading Firmware



- Make sure that the type and format of the firmware file are correct. Do not modify the file name. Otherwise, the inverter may not work properly.
- Do not modify the folder name and file path where the firmware files are located, as this may cause the upgrade to fail.

### Upgrade preparation

- Prepare a USB drive (USB 2.0/3.0, ≤32 GB, FAT 16 / 32).
- Check for the current firmware version of the inverter.
- Contact our service support for the update firmware file( "\*.bin" and "\*.txt" file), and store the two files in the root path of the U disk.
  - » 323101012700\_FORTH\_ALL\_V027.00\_20240806.bin
  - » updateConfig.txt

The bin name listed in the "\*.txt" file must be same as the "\*.bin" name.

### Upgrade steps

USB disk can be plugged when the inverter is in normal status. Plug the U disk into the upgrading port below: If the Wi-Fi dongle is connected to the port, please remove the dongle first.

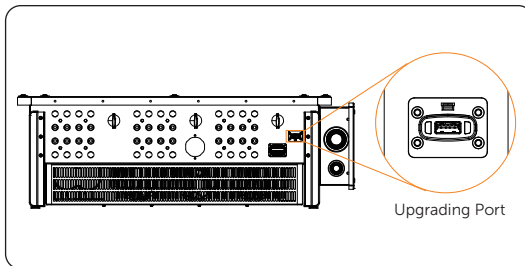

Figure 11-2 Finding the upgrading port

- For inverters with LED indicators:
  - Wait approximately 15 seconds. The system will start upgrading.
  - When the buzzer stops buzzing and the indicator lights start blinking again, it means that ARM program is upgraded successfully. And then the system will start other programs by upgrading.
  - After upgrading finished, the current state of indicator will be kept for 1 Min and the inverter will be switched on automatically.

NOTICE!

- If upgrading succeeds, the communication indicator (blue) turns off and other indicators are on.
- If upgrading fails, only alarm indicator (red) is on. Please contact our service support for solutions.

- For inverters with LCD Screen:

During upgrading process, users can see the steps of the upgrade displayed on the LCD screen.

==MCUisUpgrading==  
Upgrading  
ARM

==MCUisUpgrading==  
Upgrading  
MDSP

==MCUisUpgrading==  
Upgrading  
ARC

==MCUisUpgrading==  
Upgrading  
SDSP

After the upgrade is complete, the screen will display the upgrade result.

==UpgradeResult==  
Upgrade  
SUCCESS

# 12 Decommissioning

## 12.1 Disassembling the Inverter

### WARNING!

Strictly follow the steps below to disassemble the inverter.

- Only use the dedicated removal tool to disassemble the PV connector.
- Before dismantling the inverter, please be sure to turn off the DC switch and AC breaker, and then unplug the PV and AC cables, otherwise it will lead to an electric shock hazard.

**Step 1:** Switch off the DC and AC switch/breaker and disconnect the inverter from DC input and AC output. Wait for 5 minutes for de-energizing.

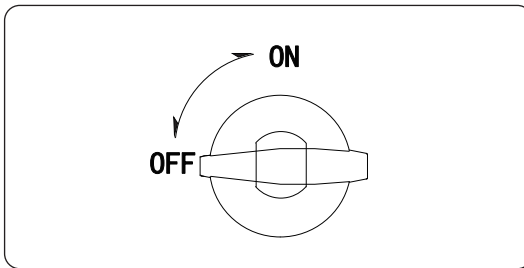

Figure 12-1 Turning off the DC switch

**Step 2:** Disconnect the PV connectors. Insert the disassembling tool for PV terminal (part H\*) to the slot of the AC connector to release it. Slight pull the connectors. Disassembling the dust proof buckles and the PV cables

### NOTICE!

- For some counties or regions, the disassembling tool is not included in the packing list. Please refer to the actual delivery.

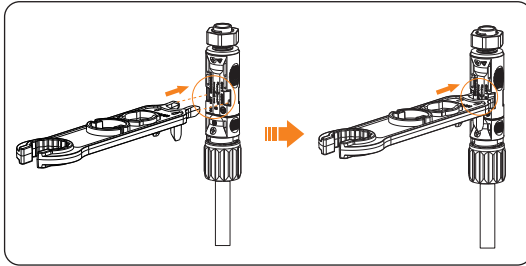

Figure 12-2 Disassembling the PV connector and the PV cable

- Step 3:** Slightly pull out the dongle module.
- Step 4:** Open the AC wiring box and disconnect the AC connectors.
- Step 5:** Disconnect communication and optional connection wirings.

For releasing the communication cable, please keep the buttons on the two sides, pressed and pull out the cable to make it unlocked.

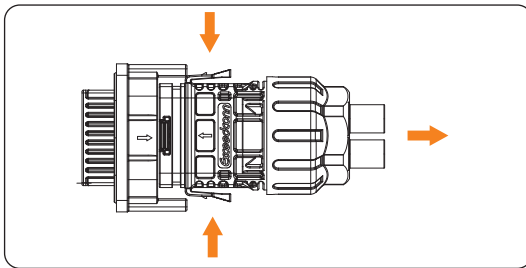

Figure 12-3 Releasing the communication cable

- Step 6:** Put the original terminal caps on the terminals.
- Step 7:** Unscrew the grounding screw by cross-head screw and remove the grounding cable.
- Step 8:** Remove the inverter from the bracket.
- Step 9:** Unscrew the screws for fastening the wall mounting or stand mounting bracket and remove bracket if needed.

## 12.2 Packing the Inverter

- Use the original packaging materials if available.

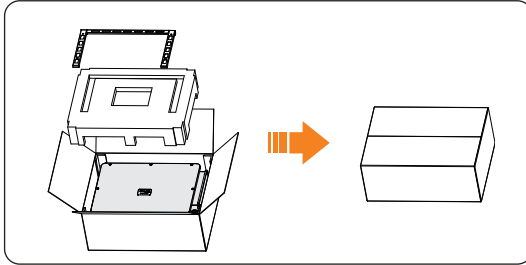

Figure 12-4 Packing the inverter

- If the original packing material is not available, use the packing material which meets the following requirements:
  - » Suitable for the weight and dimension of product
  - » Convenient for transportation
  - » Can be sealed with adhesive tape

## 12.3 Disposing of the Inverter

Properly dispose of the inverter and accessories in accordance with local regulations on the disposal of electronic waste.

# 13 Technical Data

## 13.1 DC Input

- DC input of 40kW ~ 70kW inverter

Model	X3-FTH-40K-LV	X3-FTH-50K-LV	X3-FTH-60K-LV	X3-FTH-70K-LV
Max. PV array input power [kWp]	60	75	90	105
Working voltage range [d.c. V] <sup>o</sup>	180-650			
Full-load MPPT voltage range [d.c. V] <sup>a</sup>	300-600			
Nominal input voltage [d.c. V]	360			
Max. PV input voltage [d.c. V] <sup>a</sup>	800			
Startup voltage [d.c. V]	200			
No. of MPP trackers	6		9	
Strings per MPP tracker	2			
Max. PV input current per MPPT [d.c. A]	32			
Max. short circuit current per MPPT [d.c. A]	46			
Max. inverter backfeed current to the array [d.c. A]	0			

- DC input of 75kW ~ 150kW inverter

Model	X3-FTH-75K(L)	X3-FTH-80K(L)	X3-FTH-99.9K(L)	X3-FTH-100K(L)	X3-FTH-110K(L)	X3-FTH-120K(L)	X3-FTH-125K(L)	X3-FTH-136K-MV(L)	X3-FTH-150K-MV(L)
	X3-FTH-75K	X3-FTH-80K		X3-FTH-100K	X3-FTH-110K	X3-FTH-120K	X3-FTH-125K	X3-FTH-136K-MV	X3-FTH-150K-MV
Max. PV array input power [kWp]	120	120	150	150	165	180	188	204	225
Working voltage range [d.c. V] <sup>o</sup>	180-1000								
Full-load MPPT voltage range [d.c. V] <sup>a</sup>	500-800 625-850	500-800 625-850	500-800	500-800 625-850	500-800 625-850	500-800 625-850	500-800 625-850	567-800	625-800
Nominal input voltage [d.c. V] <sup>c</sup>	580/600 /700	580/600 /700	580/600	580/600 /700	580/600 /700	580/600 /700	580/600 /700	730/785	730/785
Max. PV input voltage [d.c. V] <sup>a</sup>	1100								
Startup voltage [d.c. V]	200								
No. of MPP trackers	9	9	9	9 (Optional 12)	9 (Optional 12)	12	12	12	12

## Technical Data

Model	X3-FTH-75K(L)	X3-FTH-80K(L)	X3-FTH-99.9K(L)	X3-FTH-100K(L)	X3-FTH-110K(L)	X3-FTH-120K(L)	X3-FTH-125K(L)	X3-FTH-136K-MV(L)	X3-FTH-150K-MV(L)
Strings per MPP tracker	75K	80K	99.9K	100K	110K	120K	125K	136K-MV	150K-MV
Max. PV input current per MPPT [d.c. A]					32				
Isc PV Array Short Circuit current per MPPT [d.c. A]					46				
Max. inverter backfeed current to the array [d.c. A]					0				

### NOTICE!

- The maximum input voltage is the highest voltage the inverter's DC input can safely handle. Exceeding this voltage may damage the inverter.
- If the input voltage is not within the working voltage range, the inverter will not function properly.
- The two data refer to different grid voltage 220V/230V or 500V/540V.

## 13.2 AC Output

- AC output of 40kW ~ 70kW inverter

Model	X3-FTH-40K-LV	X3-FTH-50K-LV	X3-FTH-60K-LV	X3-FTH-70K-LV
Nominal AC output power [kW]	40	50	60	70
Nominal AC output current [a.c. A]	105	131.3	157.5	183.7
Max. AC output apparent power [kVA]	44	55	66	70
Max. AC output current [a.c. A]	115.5	144.5	173.5	183.7
Current (inrush) [a.c. A]	115.5	144.5	173.5	183.7
Nominal AC voltage [a.c. V]	127/220, 3W/(N)/PE			
Nominal AC frequency/AC frequency range [Hz]**	50/60; ±5			
Displacement power factor	0.8 leading - 0.8 lagging			
THDi (Rated power) [%]	<3%			
Max. output fault current [a.c. A]	370			
Max. output overcurrent protection [a.c. A]	370			

- AC output of 75kW ~ 150kW inverter

Model	X3-FTH-75K(L) X3-FTH-75K	X3-FTH-80K(L) X3-FTH-80K	X3-FTH-99.9K(L)	X3-FTH-100K(L) X3-FTH-100K	X3-FTH-110K(L) X3-FTH-110K	X3-FTH-120K(L) X3-FTH-120K	X3-FTH-125K(L) X3-FTH-125K	X3-FTH-136K-MV(L) X3-FTH-136K-MV	X3-FTH-150K-MV(L) X3-FTH-150K-MV
Rated AC output power [kW]	75	80	99.9	100	110	120	125	136	150
Rated AC output current [a.c. A] <sup>c</sup>	90.3/ 113.7/ 108.7	96.3/ 121.3/ 116	151.4/ 144.8	120.3/ 151.6/ 145	132.4/ 166.7/ 159.5	144.4/ 181.9/ 174	144.4/ 189.4/ 181.2	157.1/ 145.4	173.2/ 160.4
Max. AC output apparent power [kVA]	75/82.5	88	109.9	110	121	132	132	149.6	165
Max. AC output current [a.c. A] <sup>c</sup>	99.3/ 113.7/ 108.7	105.9/ 133.4/ 127.6	166.5/ 159.3	132.4/ 166.7/ 159.5	145.6/ 183.4/ 175.4	158.8/ 200/ 191.3	158.8/ 200/ 191.3	172.8/ 160	190.6/ 176.5
Current (inrush) [A] <sup>c</sup>	99.3/ 113.7/ 108.7	105.9/ 133.4/ 127.6	166.5/ 159.3	132.4/ 166.7/ 159.5	145.6/ 183.4/ 175.4	158.8/ 200/ 191.3	158.8/ 200/ 191.3	172.8/ 160	190.6/ 176.5
Nominal AC voltage [a.c. V]	220/380, 230/400, 3W/(N)/PE 277/480, 3 L/ (N) / PE							500/540, 3W/PE	
AC voltage range [a.c. V] <sup>d</sup>	304 - 480							425 - 594	
Nominal AC frequency/ AC frequency range [Hz] <sup>d</sup>						50/60; ±5			
THDi (Rated power) [%]						<3			
Power Factor range						0.8 leading - 0.8 lagging			
Max. output fault current [a.c. A]						370			
Max. output overcurrent protection [a.c. A]						370			

### NOTICE!

- c. The two data refer to different grid voltage 220V/230V or 500V/540V.  
 d. The AC voltage and the frequency range may vary from different country codes.

## 13.3 System data

- System data of 40kW ~ 70kW inverter

Model	X3-FTH-40K-LV	X3-FTH-50K-LV	X3-FTH-60K-LV	X3-FTH-70K-LV
Max. efficiency [%]	98.0			
Protection level	IP66			
Operating temperature range [°C]	-25 to +60			
Max. operation altitude [m]	4000			
Relative humidity [%]	0-100			
Dimensions (W × H × D) [mm]	985 × 660 × 327.5			
Weight [kg]	80.5			83

## Technical Data

Model	X3-FTH-40K-LV	X3-FTH-50K-LV	X3-FTH-60K-LV	X3-FTH-70K-LV
Cooling concept	Smart fan cooling			
Overvoltage Category	III(MAINS), II(DC)			
Communication interfaces	RS485 / (Optional: Pocket Wifi/LAN/4G) / USB			

- System data of 75kW ~ 150kW inverter

Model	X3-FTH-75K(L) X3-FTH-75K	X3-FTH-80K(L) X3-FTH-80K	X3-FTH-99.9K(L)	X3-FTH-100K(L) X3-FTH-100K	X3-FTH-110K(L) X3-FTH-110K	X3-FTH-120K(L) X3-FTH-120K	X3-FTH-125K(L) X3-FTH-125K	X3-FTH-136K-MV(L) X3-FTH-136K-MV	X3-FTH-150K-MV(L) X3-FTH-150K-MV
Max. efficiency [%]	98.6/ 98.8	98.6/ 98.8	98.6	98.6/ 98.8	98.6/ 98.8	98.6/ 98.8	98.6/ 98.8	99.0	99.0
European weighted efficiency [%]	98.3/98.4	98.3/98.4	98.3	98.3/98.4	98.3/98.4	98.3/98.4	98.3/98.4	98.5	98.5
Ingress protection	IP66								
Operating ambient temperature range [°C]	-25 to +60								
Max. operation altitude [m]	4000								
Relative humidity [%]	0-100								
Dimensions (W x H x D) [mm]	985 x 660 x 327.5								
Weight [kg]	83			87					
Cooling concept	Smart fan cooling								
Communication interfaces	RS485 / USB / DRM								
Optional monitoring dongle	Pocket WiFi/LAN/4G								
Display	LCD(16x2, optional)/LEDx4								
Overvoltage Category	III(MAINS), II(DC)								

## 13.4 Protection

- Protection of 40kW ~ 70kW inverter

Model	X3-FTH-40K-LV	X3-FTH-50K-LV	X3-FTH-60K-LV	X3-FTH-70K-LV
DC Switch	Yes			
Over/under voltage protection	Yes			
DC isolation protection	Yes			
Grid monitoring	Yes			
DC injection monitoring	Yes			
Residual current detection	Yes			

Model	X3-FTH-40K-LV	X3-FTH-50K-LV	X3-FTH-60K-LV	X3-FTH-70K-LV
Active anti-islanding method	Frequency shift			
Pollution degree	PD 3			
String fault detection	Yes			
Arc-fault circuit interrupter(AFCI)*	Optional (AFCI type: F-I-AFPE-1-2-6)		Optional (AFCI type: F-I-AFPE-1-2-9)	
SPD (DC/AC)	Type II/Type II			

**NOTICE!**

- e. AFCI Type: F-I-AFPE-1-2-6
  - Full coverage
  - Integrated
  - AFPE
  - 1 monitored string per input port,
  - 2 input ports per channel,
  - 6 monitored channels.
- AFCI Type: F-I-AFPE-1-2-9
  - Full coverage
  - Integrated
  - AFPE
  - 1 monitored string per input port,
  - 2 input ports per channel,
  - 9 monitored channels.

• Protection of 75kW ~ 150kW inverter

Model	X3-FTH-75K(L)	X3-FTH-80K(L)	X3-FTH-99.9K(L)	X3-FTH-100K(L)	X3-FTH-110K(L)	X3-FTH-120K(L)	X3-FTH-125K(L)	X3-FTH-136K-MV(L)	X3-FTH-150K-MV(L)	
Over/under voltage protection					Yes					
DC isolation protection					Yes					
Grid monitoring					Yes					
DC injection monitoring					Yes					
Residual current detection					Yes					
Active anti-islanding method					Frequency shift					
Pollution degree					PD 3					
String fault detection					Yes					
SPD (DC/AC)					Type II/Type II					
Arc-fault circuit interrupter(AFCI)*	Optional (AFCI type: F-I-AFPE-1-2-9)			Optional (AFCI type: F-I-AFPE-1-2-12)		Optional (AFCI type: F-I-AFPE-1-2-12)		/		

## Technical Data

Model	X3-FTH-75K(L) X3-FTH-75K	X3-FTH-80K(L) X3-FTH-80K	X3-FTH-99.9K(L)	X3-FTH-100K(L) X3-FTH-100K	X3-FTH-110K(L) X3-FTH-110K	X3-FTH-120K(L) X3-FTH-120K	X3-FTH-125K(L) X3-FTH-125K	X3-FTH-136K-MV(L) X3-FTH-136K-MV	X3-FTH-150K-MV(L) X3-FTH-150K-MV
AC terminals over temperature detection						Yes			
AC auxiliary power supply(APS)						Yes			

### NOTICE!

- f. AFCI Type: F-I-AFPE-1-2-9
- Full coverage
  - Integrated
  - AFPE
  - 1 monitored string per input port,
  - 2 input ports per channel,
  - 9 monitored channels.
- AFCI Type: F-I-AFPE-1-2-12
- Full coverage
  - Integrated
  - AFPE
  - 1 monitored string per input port,
  - 2 input ports per channel,
  - 12 monitored channels.

## 13.5 Standard

- Standard of 40kW ~ 70kW inverter

Model	X3-FTH-40K-LV	X3-FTH-50K-LV	X3-FTH-60K-LV	X3-FTH-70K-LV
Safety Standard	IEC/EN 62109-1; IEC/EN 62109-2; NB/T 32004			
EMC	IEC/EN 61000; NB/T 32004			
Certification	NB/T 32004; IEC 61727; IEC 62116; VDE4110; VDE4105; EN50549; NRS097; G99; RD1699; PPDS; CEI0-21; CEI0-16; VFR 2019; IEC 61683; IEC 60068; EN 50530; AS4777.2			

- Standard of 75kW ~ 150kW inverter

Model	X3-FTH-75K(L) X3-FTH-75K	X3-FTH-80K(L) X3-FTH-80K	X3-FTH-99.9K(L)	X3-FTH-100K(L) X3-FTH-100K	X3-FTH-110K(L) X3-FTH-110K	X3-FTH-120K(L) X3-FTH-120K	X3-FTH-125K(L) X3-FTH-125K	X3-FTH-136K-MV(L) X3-FTH-136K-MV	X3-FTH-150K-MV(L) X3-FTH-150K-MV
Safety	IEC/EN 62109-1; IEC/EN 62109-2; NB/T 32004								
EMC	IEC/EN 61000; NB/T 32004								
Certification	NB/T 32004; IEC 61727; IEC 62116; VDE4110; VDE4105; EN50549; NRS097; G99; RD1699; PPDS; CEI0-21; CEI0-16; VFR 2019; IEC 61683; IEC 60068; EN 50530; AS4777.2; UL1741; NOM-001								

# 14 Appendix

## 14.1 Control Output Power with RRCR

The inverter can be connected to a RRCR (Radio Ripple Control Receiver) in order to dynamically control the output power of all the inverters. Users can control and limit the active power on the LCD by setting the active power limitation, which is a fixed power limit as a percentage, i.e. 0%, 30%, 60% and 100%.

- Connecting procedure

Connect the RRCR directly to the inverter communication board through the DRM.

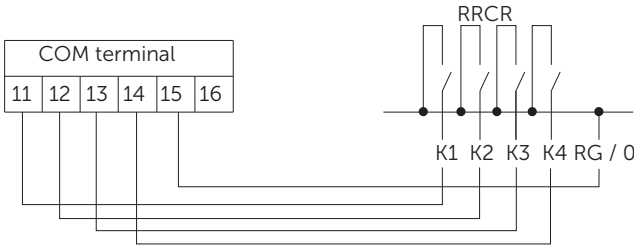

Figure 14-5 RRCR connection diagram

Table 14-3 Connector pin assignment and functionality

Port	Pin	Definition	Description	Connect to RRCR
DRM/RRCR	11	DRM1 / 5	Input 1	K1 - Relay 1 output
	12	DRM2 / 6	Input 2	K2 - Relay 2 output
	13	DRM3 / 7	Input 3	K3 - Relay 3 output
	14	DRM4 / 8	Input 4	K4 - Relay 4 output
	15	RG / 0	VCC	Relays common node

Table 14-4 Preconfigured RRCR power levels for the inverter

COM port Pin 11	COM port Pin 12	COM port Pin 13	COM port Pin 14	Active power	Cos( $\varphi$ )
Short circuit with RG/0	/	/	/	0%	1
/	Short circuit with RG/0	/	/	30%	1

COM port Pin 11	COM port Pin 12	COM port Pin 13	COM port Pin 14	Active power	Cos( $\varphi$ )
/	/	Short circuit with RG / 0	/	60%	1
/	/	/	Short circuit with RG / 0	100%	1

- Fixed power control setting procedure

Enter "Active Power" page, choose "Enable" to activate the function.



In the "RRCR" page. RRCR1 2, 3, 4 can be set for the corresponding values 0%, 30%, 60%, and 100% by default. Users can also configure these values as needed.

The values correspond to varied AC output power. For example, the 30% is in accordance with the rated power output of 30%.

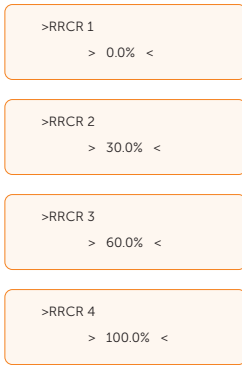

## 14.2 Application of Parallel Function

### Datahub Parallel Connection

The series inverter provides the parallel connection function when connected with Datahub, which could support at most 60 inverters to parallel in one system and can control zero injection to the grid with a meter installed in the main circuit. In this parallel system, the Datahub will be the master of the system, and all the inverters are the slaves. The Datahub can communicate with all the slave inverters.

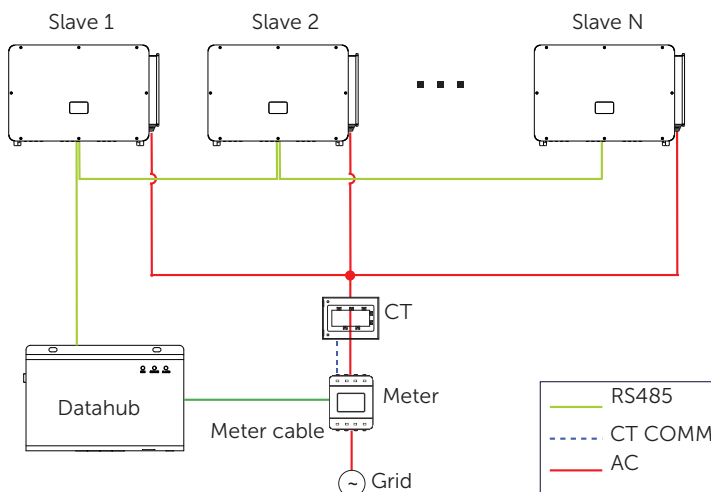

Figure 14-1 Parallel system diagram with Datahub

#### NOTICE!

- Before operation, please make sure that the inverters meet the following conditions:
  1. All the inverters are recommended to be the same series;
  2. The firmware version of all inverters shall be the same. Otherwise, the parallel function cannot be used.
  3. Ensure the RS485 cable length is less than 200 m.

### Wiring operation

- Step 1:** Connect one end of an RS485 communication cable with Datahub, and the other end with one of the slave inverters.
- Step 2:** Connect all the slave inverters with each other with RS485 cables.
- Step 3:** Connect the meter with the Datahub and the mains.

NOTICE!

- For details on the wiring operation of Datahub, see *Datahub Installation Guide*.

Modbus Parallel Connection

The device offers master-slave parallel connection for up to 10 devices, with one serving as the master and the others as slaves. A 485 communication wire must be attached directly to the inverter.

The devices are connected in a daisy chain type connection mode. The Master's RS485-2 is connected to the electricity meter, and the master and slave are connected to the RS485 1 port.

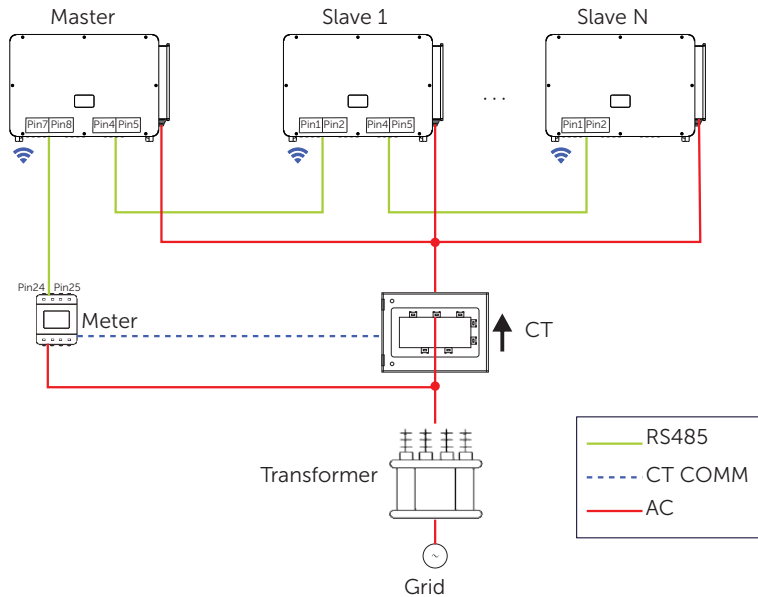
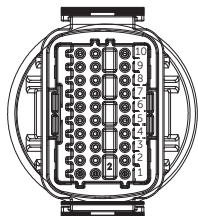

Figure 14-2 Parallel system diagram with Modbus

The interconnection between the host and slave is made by Pins 1, 2, 4, 5, and Pins 7, 8, which are connected to the electricity meter.



Port	Pin	Definition
RS-485-1	1	RS485A IN+
	2	RS485B IN-
	4	RS485A OUT+
	5	RS485A OUT-
RS-485-2	7	RS485A METER
	8	RS485B METER

## Setting procedure

- Slave setup:

The slave device needs to set its Modbus address and baud rate. Set the Modbus address of the slave device on the power station to 2 ~ 11 (up to 10 devices are supported at present) and the baud rate to 9600.

```

==Communication Parameter==
>Modbus Addr
2
  
```

```

==Communication Parameter==
>Modbus Baud
9600
  
```

- Meter setup:

Set the Modbus address of the meter to 1 and the baud rate to 9600.

- Master setup:

The equipment connected to the meter is selected as the Master, and the Master mode and anti-reflux function of the Master equipment on the power station are enabled by APP / web page / screen, among which System Limit are set to 100%.

```

===Limit Set===
>System Limit
>100.0%<
  
```



## **SolaX Power Network Technology (Zhejiang) Co., Ltd.**

Add.: No. 278, Shizhu Road, Chengnan Sub-district, Tonglu County,  
Hangzhou, Zhejiang, China  
E-mail: [info@solaxpower.com](mailto:info@solaxpower.com)